



CONTROL
HEEL
2024-25



CONTROL
TECH
2024-25

The logo features the words "CONTROL" and "TECH" in a bold, italicized, sans-serif font. Below them, the year "2024-25" is written in a smaller, italicized font. The entire text is set against a background of several parallel diagonal lines that create a sense of motion and depth.

INDEX

NEW PRODUCTS 6

NON SERIES 86

ACCESSORIES 92

**DISCONTINUED
PRODUCT** 98

ROAD		MTB		EI	82
COUGAR	12	TIMANIA	40	TRIATHLON	68
TIMANIA	16	TUX	42		
TUX	18	EXL	44		
EXL	20	SLA	46		
SLA	22	CLS	48		
CLS	24	LYNX	50		
FALCON	28	ONE	56		
ONE	30	OE	58		
OE	33				



Ride With Better Control

NEW

PRODUCTS

SIROCCO INTEGRATED CARBON HANDLEBAR

RA-550
 MATERIAL: UD CARBON
 BARBORE Ø: 31.8MM
 WIDTH: 400/420/440MM
 REACH: 75MM
 DROP: 125MM
 FLARE: 0°
 WEIGHT: 275G(420MM)TBD
 COMPATIBLE WITH EW-RS910



SIROCCO INTEGRATED -8° CARBON DROP STEM

RAS-108
 MATERIAL: UD CARBON
 HANDLEBAR Ø: 31.8MM
 STEERER Ø: 28.6MM
 LENGTH: 90/100/110/120MM
 ANGLE: -8°
 WEIGHT: 186G (100MM)TBD



Triangle section for better control

SM-07
 MATERIAL: ALLOY
 WEIGHT: 32G



COUGAR FL16 INTEGRATED ALLOY HANDLEBAR

RA-552
 MATERIAL: AL6061
 BARBORE Ø: 31.8MM
 HOOD WIDTH: 400/420/440MM
 FULL WIDTH: 464/484/504MM
 REACH: 78MM
 DROP: 125MM
 FLARE: 16°
 WEIGHT: 348G(420MM)
 COMPATIBLE WITH EW-RS910

HOOD WIDTH	
HOOD	FULL
400	464
420	484
440	504



Internal cable routing system

COUGAR -8° SEMI-INTERNAL STEM

RAS-114
 MATERIAL: AL6061
 HANDLEBAR Ø: 31.8MM
 STEERER Ø: 1-1/8"
 LENGTH: 80/90/100/110/120MM
 ANGLE: -8°
 WEIGHT: 217G (100MM)TBD



RA-531 WITH RAS-114

EXL FL6 GRAVEL CARBON HANDLEBAR

RA-556
 MATERIAL: UD CARBON
 BARBORE Ø: 31.8MM
 WIDTH: 380/400/420/440MM
 REACH : 75MM
 DROP: 125MM
 FLARE: 6°
 WEIGHT: TBD
 COLOR: GRAY
 COMPATIBLE WITH EW-RS910

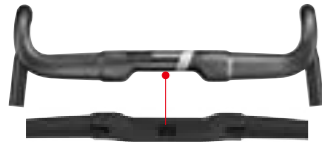

Internal cable routing system

COUGAR -8° FULL INTERNAL STEM

RAS-116
 MATERIAL: AL6061
 HANDLEBAR Ø: 31.8MM
 STEERER Ø: 1-1/8"
 LENGTH: 80/90/100/110/120/130MM
 ANGLE: -8°
 WEIGHT: 198G (100MM)



LYNX INTEGRATED -10° DROP STEM

ATB-965
 MATERIAL: AL6061
 HANDLEBAR Ø: 31.8MM
 STEERER Ø: 1-1/8"
 LENGTH: 80/90/100MM
 ANGLE: -10°
 WEIGHT: 178G (100MM)



SIROCCO AERO MINI CLIP-ON

TTH-27
 MATERIAL: REINFORCED ENGINEERING PLASTIC
 LENGTH: 140MM
 EXTENSION BAR ANGLE: 45°
 HANDLEBAR MOUNTED Ø: 31.8MM
 WEIGHT: 336G(TBD)



SIROCCO REAR HYDRATION SYSTEM

BC-40B/BC-40(With bottle cages)
 MATERIAL: AL6061+PLASTIC
 CAPACITY: 2 BOTTLES / 2 CO2 CANISTER
 ADJUSTMENT: ANGLE UP TO 90 DEGREE
 WEIGHT: BC-40B 180G / BC-40 263G



LYNX BOOST HUB

HUB-48
 MATERIAL: AL6061
 SPOKE HOLES: F/R 32
 FRONT HUB: OLD 110MM, TA-15
 REAR HUB OLD 148MM, TA-12
 WEIGHT: F 199G / R 320G
 ROTOR: STANDARD 6-BOLT
 FREEHUB: ALLOY, SHIMANO 115 HG OR SHIMANO 12 S
 MICROSPLINE OR SRAM XD DRIVE



LYNX SUPER BOOST HUB

HUB-49
 MATERIAL: AL6061
 SPOKE HOLES: F/R 32
 FRONT HUB: OLD 110MM, TA-15
 REAR HUB OLD 157 MM, TA-12
 WEIGHT: F 199G / R 330G
 ROTOR: STANDARD 6-BOLT
 FREEHUB: ALLOY, SHIMANO 115 HG OR SHIMANO 12 S
 MICROSPLINE OR SRAM XD DRIVE



COUGAR FL25 OFF-RAD GRAVEL HANDLEBAR

RA-557
 MATERIAL: AL6061
 BARBORE Ø: 31.8MM
 WIDTH: 400/420/440MM
 REACH : 78MM
 DROP: 125MM
 FLARE: 25°
 WEIGHT: 340G(420MM)

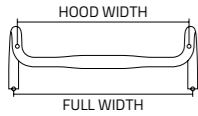

HOOD	FULL
400	510
420	530
440	550

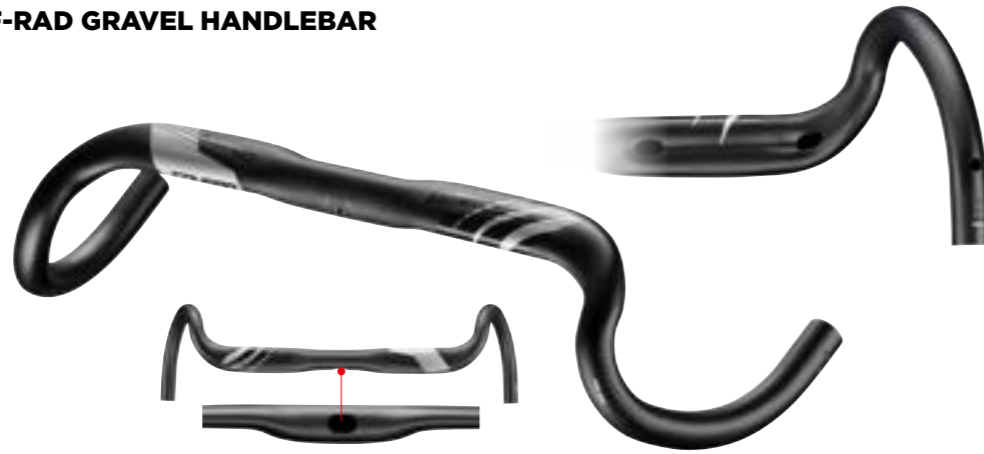

Internal cable routing system

ONE FL16 GRAVEL HANDLEBAR

RA-558
 MATERIAL: AL6061
 BARBORE Ø: 31.8MM
 WIDTH: 400/420/440/460/480/500MM
 REACH : 70MM
 DROP: 115MM
 FLARE: 16°
 RISE: 10MM
 WEIGHT: 300G(420MM)

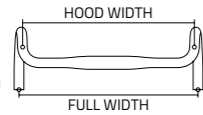

HOOD	FULL
400	454
420	474
440	494
460	514
480	534
500	554



ONE FL25 OFF-ROAD GRAVEL HANDLEBAR

RA-559
 MATERIAL: AL6061
 BARBORE Ø: 31.8MM
 WIDTH: 400/420/440/460/480/500MM
 REACH : 70MM
 DROP: 115MM
 FLARE: 25°
 RISE: 10MM
 WEIGHT: 300G(420MM)

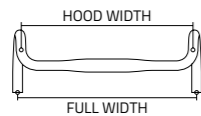

HOOD	FULL
400	494
420	514
440	534
460	554
480	574
500	594



LYNX FULL-INTERNAL INTEGRATED CARBON HANDLEBAR

ATB-321
 MATERIAL: CARBON FIBER
 STEM ANGLE: -10°
 STEM LENGTH: 50/65/80MM
 HANDLEBAR BACK SWEEP: 9°
 HANDLEBAR UPSWEEP: 4°
 HANDLEBAR LENGTH: 760/780/800MM
 WEIGHT: TBD
 COMPATIBLE TO TOKEN M-BOX



LYNX 0° ENDURO STEM

ATB-966
 MATERIAL: AL6061
 HANDLEBAR Ø: 35MM
 STEERER Ø: 1-1/8"
 LENGTH: 35MM
 ANGLE: +/-0°
 WEIGHT: 134G (35MM)



LYNX 0° ENDURO STEM

ATB-969
 MATERIAL: AL6061
 HANDLEBAR Ø: 31.8MM
 STEERER Ø: 1-1/8"
 LENGTH: 35/50MM
 ANGLE: +/-0°
 WEIGHT: TBD

TUX -8° SEMI-INTERNAL CARBON STEM

RAS-118
 MATERIAL: AL6061
 HANDLEBAR Ø: 31.8MM
 STEERER Ø: 1-1/8"
 LENGTH: 90/100/110/120MM
 ANGLE: -8°
 WEIGHT: TBD



OE 35° FULL-INTERNAL TREKKING STEM

ATB-968
 MATERIAL: AL6061
 HANDLEBAR Ø: 31.8MM
 STEERER Ø: 1-1/8"
 LENGTH: 60MM
 ANGLE: 30°
 WEIGHT: TBD



INTEGRATED SPLIT SPACER

HSS-26
 MATERIAL: PA6+30%GF
 HEIGHT: 5/10MM
 WEIGHT: 5MM/5.5G, 10MM/12.5G

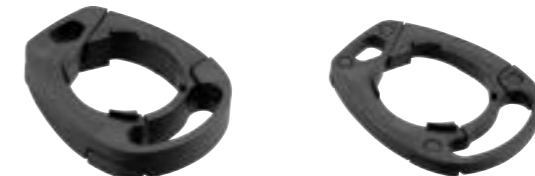

ROAD



CONTROL
LETTI

COUGAR



COUGAR FL4 CARBON HANDLEBAR

RA-522
 MATERIAL: UD CARBON
 BARBORE Ø: 31.8MM
 HOOD WIDTH: 380/400/420/440MM
 FULL WIDTH: 400/420/440/460MM
 REACH: 78MM/70(W380)
 DROP: 125MM
 FLARE: 5°
 WEIGHT: 255G(420MM)
 COMPATIBLE WITH EW-RS910

HOOD WIDTH	
[Diagram showing hood width options]	
FULL WIDTH	
HOOD	FULL
380	400
400	420
420	440
440	460

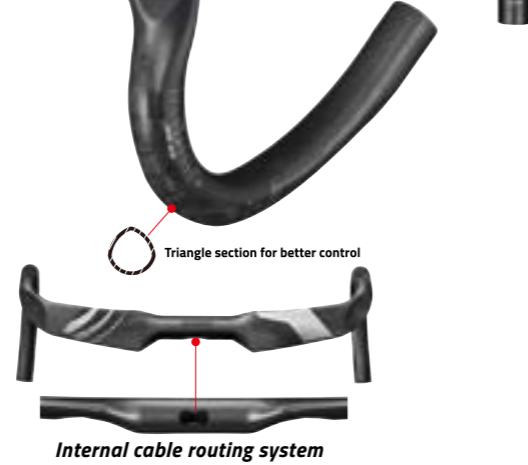

COUGAR FL4 ALLOY HANDLEBAR

RA-527
 MATERIAL: AL6061
 BARBORE Ø: 31.8MM
 HOOD WIDTH: 380/400/420/440MM
 FULL WIDTH: 400/420/440/460MM
 REACH: 75MM/70MM(W380)
 DROP: 125MM
 FLARE: 5°
 WEIGHT: 370G (420MM)
 COMPATIBLE WITH EW-RS910

HOOD WIDTH	
[Diagram showing hood width options]	
FULL WIDTH	
HOOD	FULL
380	400
400	420
420	440
440	460



COUGAR FL4 ALLOY ERGO HANDLEBAR

RA-531
 MATERIAL: AL6061
 BARBORE Ø: 31.8MM
 HOOD WIDTH: 380/400/420/440MM
 FULL WIDTH: 400/420/440/460MM
 REACH: 78MM
 DROP: 125MM
 FLARE: 4°
 WEIGHT: 348G (420MM)
 COMPATIBLE WITH EW-RS910

HOOD WIDTH	
[Diagram showing hood width options]	
FULL WIDTH	
HOOD	FULL
380	400
400	420
420	440
440	460

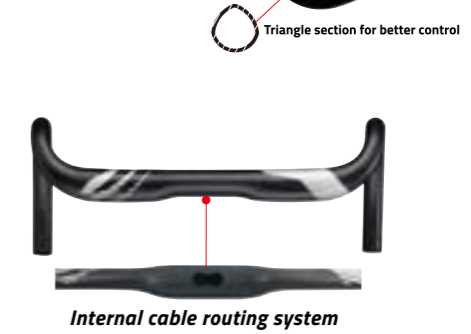

COUGAR FL4 ALLOY HANDLEBAR

RA-535
 MATERIAL: AL6061
 BARBORE Ø: 31.8MM
 HOOD WIDTH: 380/400/420/440MM
 FULL WIDTH: 400/420/440/460MM
 REACH: 78MM
 DROP: 125MM
 FLARE: 4°
 WEIGHT: 348G (420MM)
 COMPATIBLE WITH EW-RS910

HOOD WIDTH	
[Diagram showing hood width options]	
FULL WIDTH	
HOOD	FULL
380	400
400	420
420	440
440	460





COUGAR FL16 ALLOY GRAVEL HANDLEBAR

RA-552
 MATERIAL: AL6061
 BARBORE Ø: 31.8MM
 HOOD WIDTH: 400/420/440MM
 FULL WIDTH: 464/484/504MM
 REACH: 78MM
 DROP: 125MM
 FLARE: 16°
 WEIGHT: 348G(420MM)
 COMPATIBLE WITH EW-RS910

HOOD WIDTH	
HOOD	FULL
400	464
420	484
440	504

Triangle section for better control



Internal cable routing system

COUGAR -8° SEMI-INTERNAL STEM

RAS-114
 MATERIAL: AL6061
 HANDLEBAR Ø: 31.8MM
 STEERER Ø: 1-1/8"
 LENGTH: 80/90/100/110/120MM
 ANGLE: -8°
 WEIGHT: 217G (100MM)TBD



RA-531 WITH RAS-114



COUGAR -5° STEM

RAS-92
 MATERIAL: AL6061
 HANDLEBAR Ø: 31.8MM
 STEERER Ø: 1-1/8"
 LENGTH: 90/100/110/120MM
 ANGLE: -5°
 WEIGHT: 175G (100MM)



COUGAR FL25 OFF-RAD GRAVEL HANDLEBAR

RA-557
 MATERIAL: AL6061
 BARBORE Ø: 31.8MM
 WIDTH: 400/420/440MM
 REACH : 78MM
 DROP: 125MM
 FLARE: 25°
 WEIGHT: 340G(420MM)

HOOD WIDTH	
HOOD	FULL
400	510
420	530
440	550

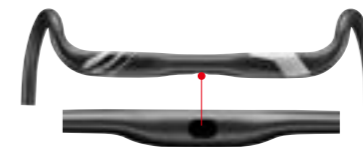

Internal cable routing system



COUGAR -6° AERO ALLOY STEM

RAS-94
 MATERIAL: AL6061
 HANDLEBAR Ø: 31.8MM
 STEERER Ø: 1-1/8"
 LENGTH: 80/90/100/110MM
 ANGLE: -6°
 WEIGHT: 240G (100MM)
 INTEGRATED STEM CAP, HIDDEN FACEPLATE BOLTS

COUGAR -8° FULL INTERNAL STEM

RAS-116
 MATERIAL: AL6061
 HANDLEBAR Ø: 31.8MM
 STEERER Ø: 1-1/8"
 LENGTH: 80/90/100/110/120/130MM
 ANGLE: -8°
 WEIGHT: 198G (100MM)



COUGAR CARBON HEX SEATPOST

SP-1570
 MATERIAL: CARBON FIBER
 DIAMETER Ø: 27.2/31.6MM
 LENGTH: 350MM
 MINIMUM INSERT: 90MM
 SETBACK: 20/10/-5/-10MM
 WEIGHT: 245G (27.2MM)



PCS COMPRESSOR FOR INTERNAL CABLE ROUTING

CAP-50
 MATERIAL: STAINLESS STEEL
 BOLT: STAINLESS STEEL
 SIZE: Ø28.5*40MM
 STEERER Ø: 1-1/8"
 WEIGHT: 39G
 UP TO 4 CABLES ARE ALLOWED FOR INTERNAL CABLE ROUTING.
 PCS COMPRESSOR

ITUX



TUX FL4 COMPACT HANDLEBAR

RA-523
 MATERIAL: UD CARBON
 BARBORE Ø: 31.8MM
 HOOD WIDTH: 380/400/420/440MM
 FULL WIDTH: 400/420/440/460MM
 REACH: 70(380)/75MM
 DROP: 125MM
 FLARE: 4°
 WEIGHT: 177G (420MM)
 COMPATIBLE WITH EW-RS910
ZEDLER PASS

HOOD WIDTH	
FULL WIDTH	
HOOD	FULL
380	400
400	420
420	440
440	460

Triangle section for better control



TUX ±5° STEM

RAS-79-FUD
 MATERIAL: CARBON FIBER+AL7075
 HANDLEBAR Ø: 31.8MM
 STEERER Ø: 1-1/8"
 LENGTH: 70/80/90/100/110/120/130MM
 ANGLE: +/- 5°
 WEIGHT: 125G (110MM)



TUX -8° SEMI-INTERNAL CARBON STEM

RAS-118
 MATERIAL: AL6061
 HANDLEBAR Ø: 31.8MM
 STEERER Ø: 1-1/8"
 LENGTH: 90/100/110/120MM
 ANGLE: -8°
 WEIGHT: TBD



TUX LIGHT SBO SEATPOST

SP-1600
 MATERIAL: CARBON FIBER
 DIAMETER Ø: 31.6MM
 LENGTH: 400MM
 MINIMUM INSERT: 100MM
 SETBACK: 0MM
 WEIGHT: 240G (31.6MM)



TUX LIGHT SB20 SEATPOST

SP-1610
 MATERIAL: CARBON FIBER
 DIAMETER Ø: 27.2MM
 LENGTH: 350MM
 MINIMUM INSERT: 90MM
 SETBACK: 20MM
 WEIGHT: 190G (27.2MM)



TUX SBO SEATPOST

SP-1620
 MATERIAL: CARBON FIBER
 DIAMETER Ø: 27.2/31.6MM
 LENGTH: 400MM
 MINIMUM INSERT: 100MM
 SETBACK: 0MM
 WEIGHT: 190G (31.6MM)



TUX SB10 SEATPOST

SP-1630
 MATERIAL: CARBON FIBER
 DIAMETER Ø: 27.2/31.6MM
 LENGTH: 350MM
 MINIMUM INSERT: 90MM
 SETBACK: 10MM
 WEIGHT: 185G (27.2MM)

EXL



EXL FL6 GRAVEL CARBON HANDLEBAR

RA-556
 MATERIAL: UD CARBON
 BARBORE Ø: 31.8
 WIDTH: 380/400/420/440MM
 REACH: 75MM
 DROP: 125MM
 FLARE: 6°
 WEIGHT: TBD
 COLOR: GRAY
 COMPATIBLE WITH EW-RS910

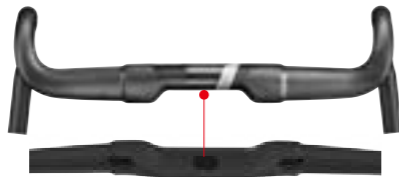

Internal cable routing system



EXL FL4 COMPACT HANDLEBAR

RA-526
 MATERIAL: UD CARBON
 BARBORE Ø: 31.8MM
 HOOD WIDTH: 420/440/460MM
 FULL WIDTH: 400/420/440MM
 REACH: 75MM
 DROP: 125MM
 FLARE: 4°
 WEIGHT: 195G (420MM)
 COMPATIBLE WITH EW-RS910

HOOD WIDTH	
400	420
420	440
420	460

FULL WIDTH	
400	420
420	440
420	460

Triangle section for better control



EXL ±5° STEM

RAS-82-FUD
 MATERIAL: CARBON FIBER+AL6061
 HANDLEBAR Ø: 31.8MM
 STEERER Ø: 1-1/8"
 LENGTH: 60/70/80/90/100/110/120/130MM
 ANGLE: +/- 5°
 WEIGHT: 128G (100MM)



EXL SB10 SEATPOST

SP-1280UD
 MATERIAL: CARBON FIBER
 DIAMETER Ø: 27.2/30.9/31.6MM
 LENGTH: 350/400MM
 MINIMUM INSERT: 90MM(350L), 100MM(400L)
 SETBACK: 10MM
 WEIGHT: 227G (27.2MM, 350L)



EXL SB23 SEATPOST

SP-1500UD
 MATERIAL: CARBON FIBER
 DIAMETER Ø: 27.2/31.6MM
 LENGTH: 350MM
 MINIMUM INSERT: 90MM
 SETBACK: 23MM
 WEIGHT: 244G (27.2MM)

ISLA



SLA FL4 COMPACT HANDLEBAR

RA-513
 MATERIAL: AL7050
 BARBORE Ø: 31.8MM
 HOOD WIDTH: 400/420/440MM
 FULL WIDTH: 420/440/460MM
 REACH: 75MM
 DROP: 125MM
 FLARE: 4°
 WEIGHT: 250G (420MM)
 COMPATIBLE WITH EW-RS910

HOOD WIDTH	
400	420
420	440
440	460

FULL WIDTH	
400	420
420	440
440	460



SLA FLO ERGO HANDLEBAR

RA-519DB7-8
 MATERIAL: AL7050
 BARBORE Ø: 31.8MM
 WIDTH: 380/400/420/440MM
 REACH: 70MM
 DROP: 125MM
 WEIGHT: 286G (420MM)



SLA SB23 SEATPOST

SP-1480
 MATERIAL: AL2014
 DIAMETER Ø: 27.2/31.6MM
 LENGTH: 350MM
 MINIMUM INSERT: 90MM
 SETBACK: 23MM
 WEIGHT: 247G (27.2MM)



SLA SB10 SEATPOST

SP-988
 MATERIAL: AL7075
 DIAMETER Ø: 27.2/30.9/31.6MM
 LENGTH: 350/400MM
 MINIMUM INSERT: 90MM(350L), 100MM(400L)
 SETBACK: 10MM
 WEIGHT: 242G (27.2MM, 350L)

SLA ±5° STEM

RAS-85
 MATERIAL: AL7075
 HANDLEBAR Ø: 31.8MM
 STEERER Ø: 1-1/8"
 LENGTH: 70/80/90/100/110/120/130MM
 ANGLE: +/- 5°
 WEIGHT: 120G (100MM)



ICLS



CL5 FL16 GRAVEL RISER

RA-530/RA-551D12
 MATERIAL: AL6061
 BARBORE Ø: 31.8MM
 HOOD WIDTH: 380/400/420/440MM
 FULL WIDTH: 473/493/513/533MM
 REACH: 75MM
 DROP: 125MM
 RISE: 20MM
 FLARE: 16°
 WEIGHT: 330G (420MM)

HOOD WIDTH	
380	473
400	493
420	513
440	533

FULL WIDTH	
HOOD	FULL
380	473
400	493
420	513
440	533



CL5 FL12 GRAVEL HANDLEBAR

RA-518DB6-8
 MATERIAL: AL6061
 BARBORE Ø: 31.8MM
 HOOD WIDTH: 400/420/440/460MM
 FULL WIDTH: 453/473/493/513MM
 REACH: 75MM
 DROP: 130MM
 FLARE: 12°
 WEIGHT: 286G (420MM)

HOOD WIDTH	
400	453
420	473
440	493
460	513

FULL WIDTH	
HOOD	FULL
400	453
420	473
440	493
460	513



CL5 FLO ROAD RISER

RA-538
 MATERIAL: AL6061
 BARBORE Ø: 31.8MM
 WIDTH: 360/380/400/420/440MM
 REACH: 70MM
 DROP: 125MM
 RISE: 20MM
 WEIGHT: 330G (420MM)



CL5 FLO ROAD HANDLEBAR

RA-510DB6-8
 MATERIAL: AL6061
 BARBORE Ø: 31.8MM
 WIDTH: 380/400/420/440MM
 REACH: 70MM
 BACK SWEEP: 6°
 DROP: 124MM (W380/400MM)
 126MM (W420/440MM)
 WEIGHT: 290G (420MM)



CLS FL4 COMPACT HANDLEBAR

RA-533/RA-544DI2
 MATERIAL: AL6061
 BARBORE Ø: 31.8MM
 HOOD WIDTH: 400/420/440MM
 FULL WIDTH: 420/440/460MM
 REACH: 75MM
 DROP: 125MM
 FLARE: 4°
 WEIGHT: 293G (420MM)
 RA-544DI2 COMPATIBLE WITH EW-RS910

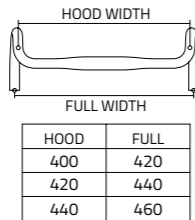

Triangle section for better control



CLS ±17° DROP STEM

RAS-117
 MATERIAL: AL6061
 HANDLEBAR Ø: 31.8MM
 STEERER Ø: 1-1/8"
 LENGTH: 70/80/90/100/110/120MM
 ANGLE: +/- 17°
 WEIGHT: 130G(100MM)



CLS ±5° STEM

RAS-110
 MATERIAL: AL6061
 HANDLEBAR Ø: 31.8MM
 STEERER Ø: 1-1/8"
 LENGTH: 60/70/80/90/100/110/120MM
 ANGLE: +/- 5°
 WEIGHT: 113G (100MM)



CLS SB10 SEATPOST

SP-1180
 MATERIAL: AL6061
 DIAMETER Ø: 27.2/31.6MM
 LENGTH: 350MM
 MINIMUM INSERT: 90MM
 SETBACK: 10MM
 WEIGHT: 285G (27.2MM, 350L)



CLS SB23 SEATPOST

SP-1480
 MATERIAL: AL6061
 DIAMETER Ø: 27.2/31.6MM
 LENGTH: 350MM
 MINIMUM INSERT: 90MM
 SETBACK: 23MM
 WEIGHT: 287G (27.2MM)

I FALCON



FALCON FLO ERGO HANDLEBAR

RA-519DB6-8
 MATERIAL: AL6061
 BARBORE Ø: 31.8MM
 WIDTH: 380/400/420/440MM
 REACH: 70MM
 DROP: 125MM
 WEIGHT: 335G (420MM)



FALCON ±5° STEM

RAS-88
 MATERIAL: AL6061
 HANDLEBAR Ø: 31.8MM
 STEERER Ø: 1-1/8"
 LENGTH: 80/90/100/110/120/130/140MM
 ANGLE: +/-5°
 WEIGHT: 170G(100MM)
 TOP CAP AND INTEGRATED SPACERS INCLUDED



FALCON -8° AERO STEM

RAS-101
 MATERIAL: AL6061
 HANDLEBAR Ø: 31.8MM
 STEERER Ø: 1-1/8"
 LENGTH: 80/90/100/110/120MM
 ANGLE: -8°
 WEIGHT: 170G (100MM)

INTEGRATED SPLIT SPACER

HSS-17
 MATERIAL: NYLON+30%GF
 HEIGHT: 5MM/10MM
 WEIGHT: 2.5G(5MM),
 5G(10MM),
 5G(HSS-11 TOP SPACER),
 7G(HSS-17 TOP SPACER)



FALCON ALLOY HEX SEATPOST

SP-1540
 MATERIAL: AL6061
 DIAMETER Ø: 27.2/31.6MM
 LENGTH: 350MM
 MINIMUM INSERT: 90MM
 SETBACK: 20/10/-5/-10MM
 WEIGHT: 380G (27.2MM)



FALCON SB20 SEATPOST

SP-1020
 MATERIAL: AL6061
 DIAMETER Ø: 27.2/31.6MM
 LENGTH: 300/350/400MM
 MINIMUM INSERT: 90MM(300/350L)
 100MM(400L)
 SETBACK: 20MM
 WEIGHT: 282G (27.2MM, 350L)

IONE



ONE FLO ROUND HANDLEBAR

RA-492DB68
 MATERIAL: AL6061
 BARBORE Ø: 31.8MM
 WIDTH: 360/380/400/420/440MM
 REACH: 70MM (360/380MM), 75MM (400/420/440MM)
 DROP: 125MM (360/380MM), 128MM (400/420/440MM)
 WEIGHT: 305G (420MM)



ONE FLO ROAD HANDLEBAR

RA-473DB6-8
 MATERIAL: AL6061
 BARBORE Ø: 31.8MM
 WIDTH: 380/400/420/440MM
 REACH: 78MM
 DROP: 140MM
 WEIGHT: 314G (420MM)



ONE FLO GRAVEL 500

RA-536
 MATERIAL: AL6061
 BARBORE Ø: 31.8MM
 WIDTH: 500MM
 REACH: 78MM
 DROP: 125MM
 RISE: 20MM
 WEIGHT: 350G



ONE FL4 GRAVEL RISER

RA-549
 MATERIAL: AL6061
 BARBORE Ø: 31.8MM
 HOOD WIDTH: 400/420/440/460/480/500MM
 FULL WIDTH: 416/436/456/476/496MM
 REACH: 70MM
 DROP: 115MM
 RISE: 10MM
 FLARE: 4°
 WEIGHT: 308G (420MM)

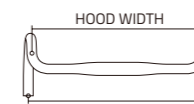

FULL WIDTH

HOOD	FULL
400	416
420	436
440	456
460	476
480	496
500	516



ONE FL16 GRAVEL HANDLEBAR

RA-558
 MATERIAL: AL6061
 BARBORE Ø: 31.8MM
 WIDTH: 400/420/440/460/480/500MM
 REACH: 70MM
 DROP: 115MM
 FLARE: 16°
 RISE: 10MM
 WEIGHT: 300G(420MM)

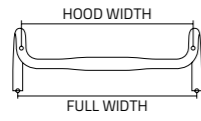

HOOD	FULL
400	454
420	474
440	494
460	514
480	534
500	554



ONE FL25 OFF-ROAD GRAVEL HANDLEBAR

RA-559
 MATERIAL: AL6061
 BARBORE Ø: 31.8MM
 WIDTH: 400/420/440/460/480/500MM
 REACH: 70MM
 DROP: 115MM
 FLARE: 25°
 RISE: 10MM
 WEIGHT: 300G(420MM)

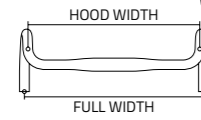

HOOD	FULL
400	494
420	514
440	534
460	554
480	574
500	594



ONE ±17° DROP STEM

RAS-217
 MATERIAL: AL6061
 HANDLEBAR Ø: 31.8MM
 STEERER Ø: 1-1/8"
 LENGTH: 70/80/90/100/110/120MM
 ANGLE: +/- 17°
 WEIGHT: 130G (100MM)



ONE ±5° STEM

RAS-80
 MATERIAL: AL6061
 HANDLEBAR Ø: 31.8MM
 STEERER Ø: 1-1/8"
 LENGTH: 60/70/80/90/100/110/120/130MM
 ANGLE: +/- 5°
 WEIGHT: 135G (100MM)



ONE SB10 SEATPOST

SP-1080
 MATERIAL: AL6061
 DIAMETER Ø: 27.2/30.9/31.6MM
 LENGTH: 350/400MM
 MINIMUM INSERT: 90MM(350L), 100MM(400L)
 SETBACK: 10MM
 WEIGHT: 285G (27.2MM, 350L)



IOE



OE FLO ROAD HANDLEBAR

RA-540
 MATERIAL: AL6061
 BARBORE Ø: 31.8MM
 WIDTH: 360/380/400/420/440MM
 REACH: 70MM
 DROP: 125MM
 WEIGHT: 300G (420MM)

OE 35° FULL-INTERNAL TREKKING STEM

ATB-968
 MATERIAL: AL6061
 HANDLEBAR Ø: 31.8MM
 STEERER Ø: 1-1/8"
 LENGTH: 60MM
 ANGLE: 30°
 WEIGHT: TBD



OE SB10 SEATPOST

SP-1640
 MATERIAL: AL6061
 DIAMETER Ø: 27.2/30.9/31.6MM
 LENGTH: 350/400MM
 MINIMUM INSERT: 90MM(350L), 100MM(400L)
 SETBACK: 10MM
 WEIGHT: 305G (27.2MM, 350L)



OE ±5° STEM

RAS-99
 MATERIAL: AL6061
 HANDLEBAR Ø: 31.8MM
 STEERER Ø: 1-1/8"
 LENGTH: 60/70/80/90/100/110/120MM
 ANGLE: +/- 5°
 WEIGHT: 135G(100MM)



ROAD COLLECTION SPEC

STEM

	RAS-108	RAS-94	RAS-92	RAS-114	RAS-116	ATB-937	RAS-79	RAS-82	RAS-85	RAS110
ANGLE	-8°	-6°	-5°	-8°	-8°	±5°	±5°	±5°	±5°	±5°
40										
45										
50										
60								V		V
70						V	V	V	V	V
80		V		V	V		V	V	V	V
90	V	V	V	V	V	V	V	V	V	V
100	V	V	V	V	V	V	V	V	V	V
110	V	V	V	V	V	V	V	V	V	V
120			V	V	V	V	V	V	V	V
130					V		V	V	V	
140										
STACK HEIGHT	32	36	35	31.2	36	40	40	40	40	40
STEERER Ø	1-1/8"	1-1/8"	1-1/8"	1-1/8"	1-1/8"	1-1/8"	1-1/8"	1-1/8"	1-1/8"	1-1/8"
BARBORE Ø	31.8	31.8	31.8	31.8	31.8	31.8	31.8	31.8	31.8	31.8
BODY	CARBON	AL6061	AL6061	AL6061	AL6061	MONOCOQUE TITANIUM	AL7075+ CARBON	AL6061+ CARBON	AL7075	AL6061
FACEPLATE	AL6061	AL6061	AL6061	AL6061	AL6061	6AL-4V TITANIUM	AL7075+ CARBON	AL6061	AL7075	AL6061
BOLT	SCM-435	SCM-435	SCM-435	SCM-435	SCM-435	6AL-4V TITANIUM	STAINLESS STEEL	SCM-435	STAINLESS STEEL	SCM-435
FINISH	CARBON	SB BLACK	SB BLACK	SB BLACK	SB BLACK	TITANIUM	CARBON	CARBON	SB BLACK	SB BLACK
WEIGHT	200G (100MM) (TBD)	240G (110MM)	182G (110MM)	129G (110MM) (TBD)	200G (100MM)	129G (110MM)	125G (110MM)	145G (110MM)	110G (110MM)	118G (110MM)

STEM

	RAS-117	RAS-88	RAS-101	RAS-80	RAS-217	RAS-99
ANGLE	±17°	±5°	-8°	±5°	±17°	±5°
40						
45						
50						
60				V		V
70	V			V	V	V
80	V	V	V	V	V	V
90	V	V	V	V	V	V
100	V	V	V	V	V	V
110	V	V	V	V	V	V
120	V	V	V	V	V	V
130		V		V		
140		V				
STACK HEIGHT	40	30.5	36	40	40	40
STEERER Ø	1-1/8"	1-1/8"	1-1/8"	1-1/8"	1-1/8"	1-1/8"
BARBORE Ø	31.8	31.8	31.8	31.8	31.8	31.8
BODY	AL6061	AL6061	AL6061	AL6061	AL6061	AL6061
FACEPLATE	AL6061	AL6061	AL6061	AL6061	AL6061	AL6061
BOLT	SCM-435	SCM-435	SCM-435	SCM-435	SCM-435	SCM-435
FINISH	SB BLACK	SB BLACK	SB BLACK	SB BLACK	SB BLACK	SB BLACK
WEIGHT	130G (100MM)	170G (100MM)	170G (100MM)	135G (100MM)	130G (100MM)	135G (100MM)

SEAT CLAMPS

TIMANIA	
MATERIAL	6AL-4V TITANIUM
ID	31.8MM/34.9MM
WEIGHT	20G(34.9MM)

SPACERS

	TIMANIA	FALCON
HEIGHT	5/10/15MM	10MM
WEIGHT	2.5/4/7G	10G

ROAD BARS

	RA-550	RA-522	RA-527	RA-531	RA-535	RA-552	RA-509	RA-523	RA-534	RA-526
BARBORE	31.8	31.8	31.8	31.8	31.8	31.8	31.8	31.8	31.8	31.8
360										
380		V	V		V			V		
400	V	V	V	V	V	V	V	V	V	V
420	V	V	V	V	V	V	V	V	V	V
440	V	V	V	V	V	V	V	V	V	V
460										
500										
DROP(MM)	125	125	125	125	125	125	130	125	125	125
REACH	75	70(W380) 78	70(W380) 75	78	78	78	75	70(W380) 75	75	75
FLARE		5°	5°	4°	4°	16°		4°	16°	4°
BACK SWEEP									6°	
RISE									20	
COMPATIBLE EW-RS910	V	V	V	V	V	V		V	V	V
MATERIAL	CARBON	CARBON	AL6061	AL6061	AL6061	AL6061	TI+CARBON	CARBON	CARBON	CARBON
FINISH	CARBON	CARBON	SB BLACK	SB BLACK	SB BLACK	SB BLACK	TITANIUM	CARBON	CARBON	CARBON
WEIGHT	275G (420MM)(TBD)	255G (420MM)	370G (420MM)	348G (420MM)	348G (420MM)	348G (420MM)(TBD)	235G (420MM)	177G (420MM)	245G (420MM)	195G (420MM)

ROAD BARS

	RA-513	RA-519	RA-510	RA-533	RA-544	RA-530	RA-551	RA-518	RA-538
BARBORE	31.8	31.8	31.8	31.8	31.8	31.8	31.8	31.8	31.8
360									V
380		V	V			V	V		V
400	V	V	V	V	V	V	V	V	V
420	V	V	V	V	V	V	V	V	V
440	V	V	V	V	V	V	V	V	V
460								V	
500									
DROP(MM)	125	125	124(W380-400) 126(W420-440)	125	125	125	125	130	125
REACH	75	70	70	75	75	75	75	75	70
FLARE	4°			4°	4°	16°	16°	12°	
BACK SWEEP			6°						
RISE						20	20		20
COMPATIBLE EW-RS910	V				V		V		
MATERIAL	AL7050	AL7075	AL6061	AL6061	AL6061	AL6061	AL6061	AL6061	AL6061
FINISH	SB BLACK	SB BLACK	SB BLACK	SB BLACK	SB BLACK	SB BLACK	SB BLACK	SB BLACK	SB BLACK
WEIGHT	250G (420MM)	286G (420MM)	290G (420MM)	293G (420MM)	293G (420MM)	330G (420MM)	330G (420MM)	286G (420MM)	330G (420MM)

ROAD BARS

	RA-519	RA-536	RA-549	RA-473	RA-492	RA-540
BARBORE	31.8	31.8	31.8	31.8	31.8	31.8
360					V	V
380				V	V	V
400	V		V	V	V	V
420	V		V	V	V	V
440	V		V	V	V	V
460			V			
480			V			
500	125	V				
DROP(MM)	70	125	115	140	125(W360-380) 128(W400-440)	125
REACH		78	70	78	70(W360-380) 75(W400-440)	70
FLARE			4°			
BACK SWEEP						
RISE		20	10			
COMPATIBLE EW-RS910	AL6061					
MATERIAL	SB BLACK	AL6061	AL6061	AL6061	AL6061	AL6061
FINISH	335G (420MM)	SB BLACK	SB BLACK	SB BLACK	SB BLACK	SB BLACK
WEIGHT		350G	308G (420MM)	314G (420MM)	305G (420MM)	300G (420MM)

SEATPOST

	SP-1570	SP-1330	SP-1610	SP-1630	SP-1280	SP-1500	SP-988	SP-1480
LENGTH (MM)	250							
	300							
	350	V	V	V	V	V	V	V
	400					V	V	
	410							
DIAMETER (MM)	27.2	V	V	V	V	V	V	V
	30.9					V	V	
	31.6	V	V		V	V	V	V
SETBACK(MM)	20/10/-5/-10	12	20	10	10	23	10	23
MATERIAL	TUBE	CARBON	3AL-2.5V TITANIUM	CARBON	CARBON	CARBON	AL7075	AL2014
	CLAMP	AL6061	CARBON	AL6066	AL2014	AL2014	AL2014	AL2014
	BOLT	SCM-435	6AL-4V TITANIUM	STAINLESS STEEL	STAINLESS STEEL	STAINLESS STEEL	STAINLESS STEEL	STAINLESS STEEL
	FINISH	CARBON	TITANIUM	CARBON	CARBON	CARBON	SB BLACK	SB BLACK
WEIGHT	245G (L350/Ø27.2)	203G (L350/Ø27.2)	190G (L350/Ø27.2)	185G (L350/Ø27.2)	227G (L350/Ø27.2)	244G (L350/Ø27.2)	242G (L350/Ø27.2)	247G (L350/Ø27.2)

SEATPOST

	SP1180	SP-1480	SP-1540	SP-1020	SP-1080	SP-1640
LENGTH (MM)	250					
	300			V		
	350	V	V	V	V	V
	400				V	V
	410					
DIAMETER (MM)	27.2	V	V	V	V	V
	30.9				V	V
	31.6	V	V	V	V	V
SETBACK(MM)	10	23	20/10/-5/-10	20	10	10
MATERIAL	TUBE	AL6061	AL6061	AL6061	AL6061	AL6061
	CLAMP	AL2014	AL2014	AL6061	AL2014	AL2014
	BOLT	STAINLESS STEEL	STAINLESS STEEL	SCM-435	STAINLESS STEEL	STAINLESS STEEL
	FINISH	SB BLACK	SB BLACK	SB BLACK	SB BLACK	SB BLACK
WEIGHT	285G (L350/Ø27.2)	287G (L350/Ø27.2)	355G (L350/Ø27.2)	282G (L350/Ø27.2)	285G (L350/Ø27.2)	305G (L350/Ø27.2)

MTB



ITUX



TUX FLAT BAR

ATB-223-8UD
 MATERIAL: CARBON FIBER
 BARBORE Ø: 31.8MM
 WIDTH: 600MM
 RISE: 0MM
 BACK SWEEP: 6°
 WEIGHT: 125G (600MM)



TUX RISER BAR

ATB-259-8UD
 MATERIAL: CARBON FIBER
 BARBORE Ø: 31.8MM
 WIDTH: 710/760MM
 RISE: 20MM
 BACK SWEEP: 9°
 UP SWEEP: 4°
 WEIGHT: 170G (710MM)



TUX FLAT TOP BAR

ATB-300-8UD
 MATERIAL: CARBON FIBER
 BARBORE Ø: 31.8MM
 WIDTH: 720/760MM
 RISE: 0MM
 BACK SWEEP: 9°
 WEIGHT: 160G (720MM)

ZEDLER PASS



TUX SL FLAT BAR (CROSS COUNTRY ONLY)

ATB-287-8UD
 MATERIAL: CARBON FIBER
 BARBORE Ø: 31.8MM
 WIDTH: 720MM
 RISE: 0MM
 BACK SWEEP: 9°
 WEIGHT: 136G



TUX SL RISER BAR (CROSS COUNTRY ONLY)

ATB-288-8UD
 MATERIAL: CARBON FIBER
 BARBORE Ø: 31.8MM
 WIDTH: 720/750MM
 RISE: 15MM
 BACK SWEEP: 9°
 UP SWEEP: 6°
 WEIGHT: 125G



TUX -8° SEMI-INTERNAL CARBON STEM

RAS-118
 MATERIAL: AL6061
 HANDLEBAR Ø: 31.8MM
 STEERER Ø: 1-1/8"
 LENGTH: 90/100/110/120MM
 ANGLE: -8°
 WEIGHT: TBD



TUX ±5° STEM

RAS-79-FUD
 MATERIAL: CARBON FIBER+AL7075
 HANDLEBAR Ø: 31.8MM
 STEERER Ø: 1-1/8"
 LENGTH: 70/80/90/100/110/120/130MM
 ANGLE: +/- 5°
 WEIGHT: 125G (100MM)

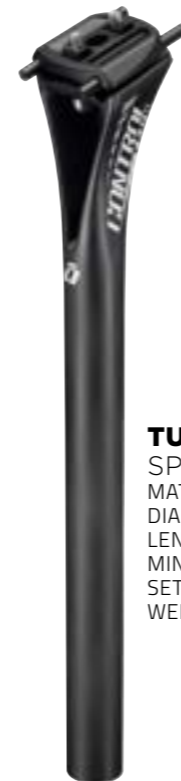

TUX LIGHT SBO SEATPOST

SP-1600
 MATERIAL: CARBON FIBER
 DIAMETER Ø: 31.6MM
 LENGTH: 400MM
 MINIMUM INSERT: 100MM
 SETBACK: 0MM
 WEIGHT: 245G (31.6MM)



TUX SBO SEATPOST

SP-1620
 MATERIAL: CARBON FIBER
 DIAMETER Ø: 27.2/31.6MM
 LENGTH: 400MM
 MINIMUM INSERT: 100MM
 SETBACK: 0MM
 WEIGHT: 190G (31.6MM)

EXL



EXL FLAT TOP BAR

ATB-303-8UD
MATERIAL: CARBON FIBER
BARBORE Ø: 31.8MM
WIDTH: 700/760/800MM
BACK SWEEP: 9°
UP SWEEP: 4°
RISE: 0MM
WEIGHT: 174G (760MM)



EXL RISER BAR

ATB-304-8UD
MATERIAL: CARBON FIBER
BARBORE Ø: 31.8MM
WIDTH: 710/750/800MM
BACK SWEEP: 9°
UP SWEEP: 4°
RISE: 20MM
WEIGHT: 189G (750MM)



EXL ±5° STEM

RAS-82-FUD
MATERIAL: CARBON FIBER+AL6061
HANDLEBAR Ø: 31.8MM
STEERER Ø: 1-1/8"
LENGTH: 60/70/80/90/100/110/120/130MM
ANGLE: +/- 5°
WEIGHT: 128G (100MM)



EXL SBO SEATPOST

SP-1270UD
MATERIAL: CARBON FIBER
DIAMETER Ø: 27.2/30.9/31.6MM
LENGTH: 350/400MM
MINIMUM INSERT: 90MM(350L), 100MM(400L)
SETBACK: 0MM
WEIGHT: 207G (27.2MM, 350L)



EXL SB10 SEATPOST

SP-1280UD
MATERIAL: CARBON FIBER
DIAMETER Ø: 27.2/30.9/31.6MM
LENGTH: 350/400MM
MINIMUM INSERT: 90MM(350L), 100MM(400L)
SETBACK: 10MM
WEIGHT: 227G (27.2MM, 350L)

ISLA



SLA FLAT BAR

ATB-262DB7-8
MATERIAL: AL7075
BARBORE Ø: 31.8MM
WIDTH: 700MM
BACK SWEEP: 9°
RISE: 0MM
WEIGHT: 248G



SLA FLAT TOP BAR

ATB-281DB7-8
MATERIAL: AL7050
BARBORE Ø: 31.8MM
WIDTH: 700/760MM
BACK SWEEP: 9°
RISE: 0MM
WEIGHT: 269G (700MM)



SLA RISER BAR

ATB-284DB7-8
MATERIAL: AL7050
BARBORE Ø: 31.8MM
WIDTH: 710/750MM
RISE: 15MM
BACK SWEEP: 9°
UP SWEEP: 4°
WEIGHT: 242G (710MM)



SLA ±5° STEM

RAS-85
MATERIAL: AL7075
HANDLEBAR Ø: 31.8MM
STEERER Ø: 1-1/8"
LENGTH: 70/80/90/100/110/120/130MM
ANGLE: +/- 5°
WEIGHT: 120G (100MM)



SLA SBO SEATPOST

SP-997
MATERIAL: AL7075
DIAMETER Ø: 27.2/30.9/31.6MM
LENGTH: 350/400MM
MINIMUM INSERT: 90MM(350L), 100MM(400L)
SETBACK: 0MM
WEIGHT: 240G (27.2MM, 350L)



SLA SB10 SEATPOST

SP-988
MATERIAL: AL7075
DIAMETER Ø: 27.2/30.9/31.6MM
LENGTH: 350/400MM
MINIMUM INSERT: 90MM(350L), 100MM(400L)
SETBACK: 10MM
WEIGHT: 242G (27.2MM, 350L)

ICLS



CLS FLAT TOP BAR

ATB-281DB6-8/ATB281DI2
 MATERIAL: AL6061
 BARBORE Ø: 31.8MM
 WIDTH: 660(DI2)/700/760MM
 RISE: 0MM
 BACK SWEEP: 9°
 WEIGHT: 268G (700MM)



CLS RISER BAR

ATB-284DB6-8/ATB281DI2
 MATERIAL: AL6061
 BARBORE Ø: 31.8MM
 WIDTH: 600(DI2)/710/750/800MM
 RISE: 15MM
 UP SWEEP: 4°
 BACK SWEEP: 9°
 WEIGHT: 305G (710MM)



CLS ±17° DROP STEM

RAS-117
 MATERIAL: AL6061
 HANDLEBAR Ø: 31.8MM
 STEERER Ø: 1-1/8"
 LENGTH: 70/80/90/100/110/120MM
 ANGLE: +/-17°
 WEIGHT: 130G(100MM)



CLS ±5° STEM

RAS-110
 MATERIAL: AL6061
 HANDLEBAR Ø: 31.8MM
 STEERER Ø: 1-1/8"
 LENGTH: 60/70/80/90/100/110/120MM
 ANGLE: +/-5°
 WEIGHT: 113G (100MM)



CLS SBO SEATPOST

SP-1420
 MATERIAL: AL6061
 DIAMETER Ø: 27.2/30.9/31.6MM
 LENGTH: 400MM
 MINIMUM INSERT: 100MM
 SETBACK: 0MM
 WEIGHT: 289G (31.6MM)



CLS SB10 SEATPOST

SP-1180
 MATERIAL: AL6061
 DIAMETER Ø: 27.2/31.6MM
 LENGTH: 350MM
 MINIMUM INSERT: 90MM
 SETBACK: 10MM
 WEIGHT: 285G (27.2MM, 350L)

LYNX

LYNX 35 CARBON FLAT TOP BAR

ATB-308/DI2
MATERIAL: CARBON FIBER
BARBORE Ø: 35.0MM
LENGTH: 710/760/800MM
BACK SWEEP: 9°
UP SWEEP: 0
RISE: 0
WEIGHT: 190G (800MM)



LYNX 35 CARBON RISER

ATB-309
MATERIAL: CARBON FIBER
BARBORE Ø: 35.0MM
LENGTH: 750/800MM
BACK SWEEP: 9°
UP SWEEP: 4°
RISE: 20MM
WEIGHT: 215G (800MM)
ZEDLER PASS

LYNX 31.8 FLAT TOP BAR

ATB-381DB6 / ATB-381DB6-DI2
MATERIAL: AL6061
BARBORE Ø: 31.8MM
WIDTH: 700/760/800MM
RISE: 0MM
BACK SWEEP: 9°
WEIGHT: 318G (800MM)
COMPATIBLE WITH SHIMANO MTB DI2 SYSTEM



LYNX 35 FLAT TOP BAR

ATB-382DB6-5
MATERIAL: AL6061
BARBORE Ø: 35MM
WIDTH: 710/760/800MM
RISE: 0MM
BACK SWEEP: 9°
WEIGHT: 314G (760MM)

LYNX 35 20MM RISER BAR

ATB-383DB6-5
MATERIAL: AL6061
BARBORE Ø: 35MM
WIDTH: 750/800MM
RISE: 20MM
UP SWEEP: 4°
BACK SWEEP: 9°
WEIGHT: 310G (750MM)

LYNX 31.8 RISER BAR

ATB-384DB6 / ATB-384DB6-DI2
MATERIAL: AL6061
BARBORE Ø: 31.8MM
WIDTH: 710/750/800MM
RISE: 15MM
UP SWEEP: 4°
BACK SWEEP: 9°
WEIGHT: 306G (710MM), 316G (750MM DI2)
COMPATIBLE WITH SHIMANO MTB DI2 SYSTEM





LYNX 35 30MM RISER

ATB-316DB65
MATERIAL: AL6061
BARBORE Ø: 35MM
WIDTH: 800MM
RISE: 30MM
UP SWEEP: 5°
BACK SWEEP: 7°
WEIGHT: 345G



LYNX 31.8 30MM RISER

ATB-317DB65
MATERIAL: AL6061
BARBORE Ø: 31.8MM
WIDTH: 620MM
RISE: 30MM
UP SWEEP: 4°
BACK SWEEP: 9°
WEIGHT: 255G



LYNX 35 TOP RISER BAR

ATB-311DB65
MATERIAL: AL6061
BARBORE Ø: 35MM
WIDTH: 750/800MM
RISE: 35MM
UP SWEEP: 4°
BACK SWEEP: 9°
WEIGHT: 306G (750MM)



LYNX 35 20MM RISER BAR

ATB-315DB65
MATERIAL: AL6061
BARBORE Ø: 35MM
WIDTH: 800MM
RISE: 20MM
UP SWEEP: 5°
BACK SWEEP: 7°
WEIGHT: 347G



LYNX FULL-INTERNAL INTEGRATED CARBON HANDLEBAR

ATB-321
MATERIAL: CARBON FIBER
STEM ANGLE: -10°
STEM LENGTH: 50/65/80MM
HANDLEBAR BACK SWEEP: 9°
HANDLEBAR UPSWEEP: 4°
HANDLEBAR LENGTH: 760/780/800MM
WEIGHT: TBD
COMPATIBLE TO TOKEN M-BOX



**LYNX 0° STEM**

ATB-956
 MATERIAL: AL6061
 HANDLEBAR Ø: 31.8MM
 STEERER Ø: 1-1/8"
 LENGTH: 40/50MM
 ANGLE: +/-0°
 WEIGHT: 149G (40MM)
 IDEAL FOR ALL MOUNTAIN &
 ENDURO 27.5 AND 29ER.

**LYNX 35 0° STEM**

ATB-957
 MATERIAL: AL6061
 HANDLEBAR Ø: 35MM
 STEERER Ø: 1-1/8"
 LENGTH: 40/50MM
 ANGLE: +/-0°
 WEIGHT: 172G (40MM)
 IDEAL FOR ALL MOUNTAIN &
 ENDURO 27.5 AND 29ER.

LYNX 0° ENDURO STEM

ATB-966
 MATERIAL: AL6061
 HANDLEBAR Ø: 35MM
 STEERER Ø: 1-1/8"
 LENGTH: 35MM
 ANGLE: +/-0°
 WEIGHT: 134G (35MM)

**LYNX 0° ENDURO STEM**

ATB-969
 MATERIAL: AL6061
 HANDLEBAR Ø: 31.8MM
 STEERER Ø: 1-1/8"
 LENGTH: 35/50MM
 ANGLE: +/-0°
 WEIGHT: TBD

**LYNX -5° DI2 STEM**

RAS-96
 MATERIAL: AL6061
 HANDLEBAR Ø: 31.8MM
 STEERER Ø: 1-1/8"
 LENGTH: 60/70MM
 ANGLE: -5°
 WEIGHT: 146G (60MM)
 FOR ALL MOUNTAIN & ENDURO 27.5 / 29ER.
 COMPATIBLE WITH SHIMANO MTB DI2.



Di2 system

**LYNX 0° DH STEM**

ATB-959
LYNX 35 0° DH STEM
 ATB-962
 MATERIAL: AL6061
 HANDLEBAR Ø: 31.8/35MM
 STEERER Ø: 1-1/8"
 LENGTH: 40/50MM
 ANGLE: +/-0°
 WEIGHT: 148G (TBD)(31.8, 40MM)
 140G (TBD)(35, 40MM)

**LYNX SADDLE II**

SD-23
 SHELL: POLYPROPYLENE
 RAILS: ALLOY
 WIDTH: 145MM
 LENGTH: 275MM
 WEIGHT: 285G
 MADE FOR TRAIL, ALL-MOUNTAIN
 AND ENDURO

**LYNX 35 0° STEM**

ATB-949
 MATERIAL: AL6061
 HANDLEBAR Ø: 35.0MM
 STEERER Ø: 1-1/8"
 LENGTH: 50/60/70/80MM
 ANGLE: +/- 0°
 WEIGHT: 140G (60MM)

**LYNX INTEGRATED -10° DROP STEM**

ATB-965
 MATERIAL: AL6061
 HANDLEBAR Ø: 31.8MM
 STEERER Ø: 1-1/8"
 LENGTH: 80/90/100MM
 ANGLE: -10°
 WEIGHT: 178G (80MM)

LYNX DROPPER SEATPOST

SP-1530
 MATERIAL: AL6066
 DIAMETER Ø: 30.9/31.6MM
 TRAVEL: 100/125/150MM
 LENGTH: 311MM(100 TRAVEL)
 361MM(125 TRAVEL)
 425MM(150 TRAVEL)
 MINIMUM INSERT: 80MM(100 TRAVEL)
 90MM(125 TRAVEL)
 100MM(150 TRAVEL)
 INSERTION DEPTH: 285MM
 WEIGHT: 590G (31.6MM, TRAVEL 125MM)
 FEATURE: ENGINEERING PLASTIC REMOTE CONTROL
 WITH GIMBALS DESIGN FOR BETTER ERGONOMICS



LYNX 27.5ER

RIM-71

LYNX 29ER

RIM-72

MATERIAL: AL6061

FRONT HUB CNC AL6061: 100X15MM, 2 BEARINGS

REAR HUB CNC AL6061: 142X12MM, 4 BEARINGS

RIM DEPTH: 21MM

RIM WIDTH: 24MM

WEIGHT: 27.5ER 1535G / PAIR, 29ER 1669G / PAIR

TUBELESS READY RIME PROFILE

SAPIM RACE 2.0/1.8/2.0 DOUBLE BUTTED ROUND SPOKES

TOOLLESS CASSETTE BODY REMOVAL FOR EASY

MAINTENANCE

COMPATIBLE WITH SHIMANO 115/SRAM 105 & XD 115

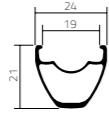

LYNX 27.5 PLUS

RIM-73

MATERIAL: AL6061

FRONT HUB CNC AL6061: 110X15MM, 2 BEARINGS

REAR HUB CNC AL6061: 148X12MM, 4 BEARINGS

RIM DEPTH: 18MM

RIM WIDTH: 40MM

WEIGHT: 1771G / PAIR

TUBELESS READY RIME PROFILE

SAPIM RACE 2.0/1.8/2.0 DOUBLE BUTTED ROUND SPOKES

TOOLLESS CASSETTE BODY REMOVAL FOR EASY MAINTENANCE

COMPATIBLE WITH SHIMANO 115/SRAM 105 & XD 115

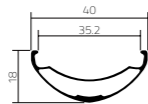

LYNX CARBON 29ER WIDE

RIM-85

MATERIAL: CARBON FIBER

FRONT HUB CNC AL6061: 110X15MM, 32 HOLES, 2 BEARINGS

REAR HUB CNC AL6061: 148X12MM, 32 HOLES, 4 BEARINGS

RIM DEPTH: 25MM

RIM WIDTH: 35MM

WEIGHT: 1695G / PAIR

TUBELESS READY RIME PROFILE

TOOLLESS CASSETTE BODY REMOVAL FOR EASY MAINTENANCE

COMPATIBLE WITH SHIMANO 115/SRAM 105 & XD 115

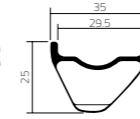

LYNX 29ER WIDE

RIM-86

MATERIAL: AL6061

FRONT HUB CNC AL6061: 110X15MM, 32 HOLES, 2 BEARINGS

REAR HUB CNC AL6061: 148X12MM, 32 HOLES, 4 BEARINGS

RIM DEPTH: 19MM

RIM WIDTH: 32MM

WEIGHT: 1845G / PAIR

TUBELESS READY RIME PROFILE

TOOLLESS CASSETTE BODY REMOVAL FOR EASY MAINTENANCE

COMPATIBLE WITH SHIMANO 115/SRAM 105 & XD 115

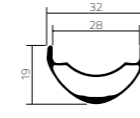

LYNX BOOST HUB

HUB-48

MATERIAL: AL6061

SPOKE HOLES: F/R 32

FRONT HUB: OLD 110MM, TA-15

REAR HUB OLD 148MM, TA-12

WEIGHT: F 199G / R 320G (TBD)

ROTOR: STANDARD 6-BOLT

FREEHUB: ALLOY, SHIMANO 115 HG OR SHIMANO 12 S

MICROSPLINE OR SRAM XD DRIVE



LYNX SUPER BOOST HUB

HUB-49

MATERIAL: AL6061

SPOKE HOLES: F/R 32

FRONT HUB: OLD 110MM, TA-15

REAR HUB OLD 157MM, TA-12

WEIGHT: F 199G / R 330G (TBD)

ROTOR: STANDARD 6-BOLT

FREEHUB: ALLOY, SHIMANO 115 HG OR SHIMANO 12 S

MICROSPLINE OR SRAM XD DRIVE



IONE



ONE FLAT BAR

ATB-210DB6-8
MATERIAL: AL6061
BARBORE Ø: 31.8MM
WIDTH: 600/700/760MM
BACK SWEEP: 6° (600MM)
BACK SWEEP: 9° (700/760MM)
WEIGHT: 244G (700MM)



ONE RISER BAR

ATB-213DB6-8
MATERIAL: AL6061
BARBORE Ø: 31.8MM
WIDTH: 660/700MM
RISE: 20MM
UP SWEEP: 6°(660MM), 5° (700MM)
BACK SWEEP: 6° (660MM), 9° (700MM)
WEIGHT: 305G (700MM)

ONE ±17° DROP STEM

RAS-217
MATERIAL: AL6061
HANDLEBAR Ø: 31.8MM
STEERER Ø: 1-1/8"
LENGTH: 70/80/90/100/110/120MM
ANGLE: +/- 17°
WEIGHT: 130G (100MM)



ONE ±5° STEM

RAS-80
MATERIAL: AL6061
HANDLEBAR Ø: 31.8MM
STEERER Ø: 1-1/8"
LENGTH: 60/70/80/90/100/110/120/130MM
ANGLE: +/- 5°
WEIGHT: 135G (100MM)



ONE SB10 SEATPOST

SP-1080
MATERIAL: AL6061
DIAMETER Ø: 27.2/30.9/31.6MM
LENGTH: 350/400MM
MINIMUM INSERT: 90MM(350L), 100MM(400L)
SETBACK: 10MM
WEIGHT: 285G (27.2MM, 350L)



OE RISER BAR

ATB-306
 MATERIAL: AL6061
 BARBORE Ø: 31.8MM
 WIDTH: 620/700/750MM
 RISE: 15MM
 BACK SWEEP: 9°
 UP SWEEP: 4°
 WEIGHT: 326G (750MM)



OE FLAT BAR

ATB-307
 MATERIAL: AL6061
 BARBORE Ø: 31.8MM
 WIDTH: 650/700/750/780MM
 BACK SWEEP: 9°
 WEIGHT: 295G (750MM)



OE CRUISER BAR

TR-678
 MATERIAL: AL6061
 BARBORE Ø: 31.8MM
 WIDTH: 630/585MM
 RISE: 22MM
 UP SWEEP: 15°
 BACK SWEEP: 35°
 WEIGHT: 304G
 COMPATIBLE WITH SHIMANO STEPS SC-E5000

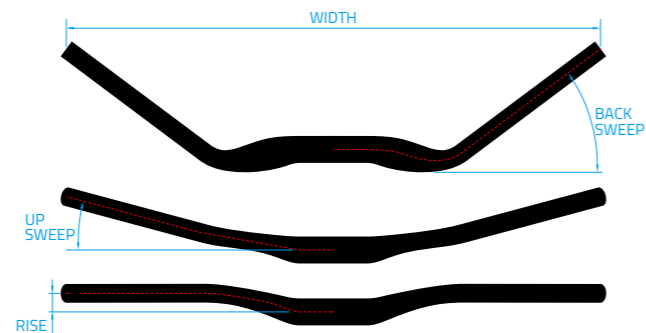

OE SB10 SEATPOST

SP-1640
 MATERIAL: AL6061
 DIAMETER Ø: 27.2/30.9/31.6MM
 LENGTH: 350/400MM
 MINIMUM INSERT: 90MM(350L), 100MM(400L)
 SETBACK: 10MM
 WEIGHT: 305G (27.2MM, 350L)



OE ±5° STEM

RAS-99
 MATERIAL: AL6061
 HANDLEBAR Ø: 31.8MM
 STEERER Ø: 1-1/8"
 LENGTH: 60/70/80/90/100/110/120MM
 ANGLE: +/-5°
 WEIGHT: 135G(100MM)



OE 35° FULL-INTERNAL TREKKING STEM

ATB-968
 MATERIAL: AL6061
 HANDLEBAR Ø: 31.8MM
 STEERER Ø: 1-1/8"
 LENGTH: 60MM
 ANGLE: 30°
 WEIGHT: TBD

MTB COLLECTION SPEC

WHEELS

	RIM-71	RIM-72	RIM-73	RIM-85	RIM-86
HUB	F:100x15mm R:142x12mm	F:100x15mm R:142x12mm	F:110x15mm R:148x12mm	F:110x15mm R:148x12mm	F:110x15mm R:148x12mm
RIM DEPTH	21MM	21MM	18MM	25MM	19MM
RIM WIDTH	24MM	24MM	40MM	35MM	32MM
WEIGHT	1535G	1669G	1771G	1695G	1845G

SEAT CLAMPS

	CAP-44
MATERIAL	6AL-4V TITANIUM
ID	31.8MM/34.9MM
WEIGHT	20G(34.9MM)

SPACERS

	HSS-12
HEIGHT	5/10/15MM
WEIGHT	2/4/7G

HUB

	HUB-48	HUB-49
HUB	F:110x15mm / R:148x12mm 32 HOLES F & R	F:110x15mm / R:157x12mm 32 HOLES F & R
MATERIAL	AL6061	AL6061
WEIGHT	F:199G / R:320G (TBD)	F:199G / R:330G (TBD)

STEM

	ATB-937	RAS-79	RAS-82	RAS-85	RAS-110	RAS-117	ATB-956	ATB-957	RAS-96	ATB-959
ANGLE	±5°	±5°	±5°	±5°	±5°	±17°	±0°	±0°	-5°	±0°
40							V	V		V
45										
50							V	V		V
60			V		V				V	
70	V	V	V	V	V	V			V	
80		V	V	V	V	V				
90	V	V	V	V	V	V				
100	V	V	V	V	V	V				
110	V	V	V	V	V	V				
120	V	V	V	V	V	V				
130		V	V	V						
STACK HEIGHT	40	40	40	40	40	40	41	43	35	47.5
STEERER Ø	1-1/8"	1-1/8"	1-1/8"	1-1/8"	1-1/8"	1-1/8"	1-1/8"	1-1/8"	1-1/8"	1-1/8"
BARBORE Ø	31.8	31.8	31.8	31.8	31.8	31.8	31.8	35	31.8	31.8
BODY	MONOCOQUE TITANIUM	AL7075+ CARBON	AL6061+ CARBON	AL7075	AL6061	AL6061	AL6061	AL6061	AL6061	AL6061
FACEPLATE	6AL-4V TITANIUM	AL7075+ CARBON	AL6061	AL7075	AL6061	AL6061	AL6061	AL6061	AL6061	AL6061
BOLT	6AL-4V TITANIUM	STAINLESS STEEL	SCM-435	STAINLESS STEEL	SCM-435	SCM-435	SCM-435	SCM-435	SCM-435	SCM-435
FINISH	TITANIUM	CARBON	CARBON	SB BLACK	SB BLACK	SB BLACK	SB BLACK	SB BLACK	SB BLACK	SB BLACK
WEIGHT	129G (100MM)	125G (100MM)	128G (100MM)	120G (100MM)	113G (100MM)	130G (100MM)	149G (40MM)	172G (40MM)	146G (60MM)	148G(31.8/L40) TBD

STEM

	ATB-965	ATB-949	RAS-80	RAS-217	RAS-99
ANGLE	-10°	±0°	±5°	±17°	±5°
40					
45					
50		V			
60		V	V		V
70		V	V	V	V
80	V	V	V	V	V
90	V		V	V	V
100	V		V	V	V
110			V	V	V
120			V	V	V
130			V		
STACK HEIGHT	35	42	40	40	40
STEERER Ø	1-1/8"	1-1/8"	1-1/8"	1-1/8"	1-1/8"
BARBORE Ø	31.8	35	31.8	31.8	31.8
BODY	AL6061	AL6061	AL6061	AL6061	AL6061
FACEPLATE	AL6061	AL6061	AL6061	AL6061	AL6061
BOLT	SCM-435	STAINLESS STEEL	SCM-435	SCM-435	SCM-435
FINISH	SB BLACK	SB BLACK	SB BLACK	SB BLACK	SB BLACK
WEIGHT	178G (80MM)	140G (60MM)	135G (100MM)	130G (100MM)	135G (100MM)

MTB BARS

	ATB-302	ATB-257	ATB-305	ATB-297	ATB-223	ATB-259	ATB-300	ATB-287	ATB-288	ATB-303	ATB-304
BARBORE	31.8	31.8	31.8	31.8	31.8	31.8	31.8	31.8	31.8	31.8	31.8
585											
600					V						
620											
640											
650											
660		V									
680											
690											
700										V	
710						V					V
720	V		V	V			V	V	V		
740											
750											V
760	V			V		V	V			V	
780											
800										V	V
BACK SWEEP	9°	5°	9°	9°	6°	9°	9°	9°	9°	9°	9°
UP SWEEP	0°	0°	0°	6°	0°	4°	0°	0°	6°	4°	4°
RISE	0	0	0	20	0	20	0	0	15	0	20
MATERIAL	3AL-2.5V TITANIUM	3AL-2.5V TITANIUM	3AL-2.5V TITANIUM	3AL-2.5V TITANIUM	CARBON	CARBON	CARBON	CARBON	CARBON	CARBON	CARBON
FINISH	TITANIUM	TITANIUM	TITANIUM	TITANIUM	CARBON	CARBON	CARBON	CARBON	CARBON	CARBON	CARBON
WEIGHT	285 (760MM)	225G (660MM)	270G (720MM)	255G (720MM)	125G (600MM)	170G (710MM)	160G (720MM)	136G (720MM)	125G (720MM)	174G (760MM)	189G (750MM)
ZEDLER							V				

MTB BARS

	ATB-262	ATB-281	ATB-284	ATB-281	ATB-284	ATB-308	ATB-309	ATB-381	ATB-382	ATB-383	ATB-384
BARBORE	31.8	31.8	31.8	31.8	31.8	35	35	31.8	35	35	31.8
585											
600					V						
620											
640											
650											
660					V						
680											
690											
700	V	V		V				V			
710			V		V	V			V		V
720											
740											
750			V		V		V			V	V
760		V		V		V		V	V		
780											
800						V	V	V	V	V	V
BACK SWEEP	9°	9°	9°	9°	9°	9°	9°	9°	9°	9°	9°
UP SWEEP	0°	0°	4°	0°	4°	0°	4°	0°	0°	4°	4°
RISE	0	0	15	0	15	0	20	0	0	20	15
MATERIAL	AL7075	AL7050	AL7050	AL6061	AL6061	CARBON	CARBON	AL6061	AL6061	AL6061	AL6061
FINISH	SB BLACK	SB BLACK	SB BLACK	SB BLACK	SB BLACK	CARBON	CARBON	SB BLACK	SB BLACK	SB BLACK	SB BLACK
WEIGHT	248G (700MM)	269G (700MM)	242G (710MM)	268G (700MM)	305G (710MM)	190G (800MM)	215G (800MM)	318G (800MM)	314G (760MM)	310G (750MM)	NON DI2 306G (710MM) DI2 316G (750MM)
ZEDLER							V				

MTB BARS

	ATB-311	ATB-315	ATB-316	ATB-317	ATB-210	ATB-213	ATB-306	ATB-307	TR-678
BARBORE	35	35	35	31.8	31.8	31.8	31.8	31.8	31.8
585									V
600					V				
620				V			V		
630									V
640									
650								V	
660						V			
680									
690									
700					V	V	V	V	
710									
720									
740									
750	V						V	V	
760					V				
780									
800	V	V	V					V	
BACK SWEEP	9°	7°	7°	9°	9°(W700/600) 4°(600)	6°(W660) 9°(W700)	9°	0°	35°
UP SWEEP	4°	5°	5°	4°	0°	6°(W660) 5°(W700)	4°	9° 6°(W640)	15°
RISE	35	20	30	30	0	20	15	0	22
MATERIAL	AL6061	AL6061	AL6061	AL6061	AL6061	AL6061	AL6061	AL6061	AL6061
FINISH	SB BLACK	SB BLACK	SB BLACK	SB BLACK	SB BLACK	SB BLACK	SB BLACK	SB BLACK	SB BLACK
WEIGHT	306G (750MM)	347G (800MM)	345G (800MM)	255G (620MM)	244G (700MM)	305G (700MM)	326G (750MM)	295G (750MM)	304G (630MM)
ZEDLER									

SEATPOST

	SP-1190	SP-1600	SP-1620	SP-1270	SP-1280	SP-997	SP-998	SP-1420	SP-1180	
LENGTH (MM)	250									
	300									
	311									
	350	V			V	V	V	V	V	
	361									
	400	V	V	V	V	V	V	V	V	
	410									
425										
DIAMETER (MM)	27.2	V		V	V	V	V	V	V	
	30.9				V	V	V	V		
	31.6	V	V	V	V	V	V	V	V	
TRAVEL(MM)	0	0	0	0	0	0	0	0	0	
SETBACK(MM)	0	0	0	0	0	0	10	0	10	
MATERIAL	TUBE	3AL-2.5V TITANIUM	CARBON	CARBON	CARBON	CARBON	AL7075	AL7075	AL6061	AL6061
	CLAMP	CARBON	AL6066	AL2014	AL2014	AL2014	AL2014	AL2014	AL2014	AL2014
	BOLT	6AL-4V TITANIUM	STAINLESS STEEL	STAINLESS STEEL	STAINLESS STEEL	STAINLESS STEEL	STAINLESS STEEL	STAINLESS STEEL	STAINLESS STEEL	STAINLESS STEEL
FINISH	TITANIUM	CARBON	CARBON	UD	UD	SB BLACK	SB BLACK	SB BLACK	SB BLACK	
WEIGHT	207G (L350/Ø27.2)	245G (L400/Ø31.6)	190G (L400/Ø31.6)	207G (L350/Ø27.2)	227G (L350/Ø27.2)	250G (L350/Ø27.2)	240G (L350/Ø27.2)	289G (L400/Ø31.6)	285G (L350/Ø27.2)	

SEATPOST

	SP-1530	SP-1080	SP-1640	
LENGTH (MM)	250			
	300			
	311	V		
	350		V	V
	361	V		
	400		V	V
	410			
425	V			
DIAMETER (MM)	27.2		V	V
	30.9	V	V	V
	31.6	V	V	V
TRAVEL(MM)	100/125/150	0	0	
SETBACK(MM)	0	10	10	
MATERIAL	TUBE	AL6066	AL6061	AL6061
	CLAMP	AL6066	AL2014	AL6061
	BOLT	SCM-435	STAINLESS STEEL	STAINLESS STEEL
FINISH	SB BLACK	SB BLACK	SB BLACK	
WEIGHT	590G (TRAVEL 125 Ø31.6)	285G (L350/Ø27.2)	305G (L350/Ø27.2)	



TRI



CONTROL
LIGHT

TT / TRI

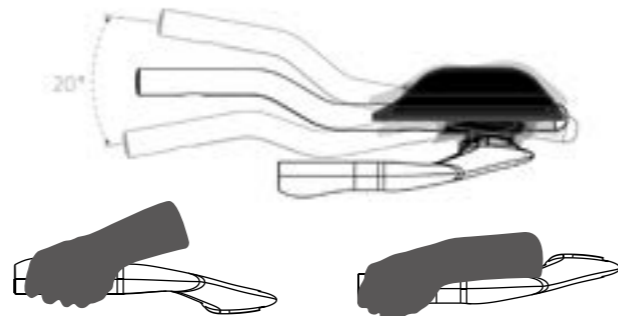
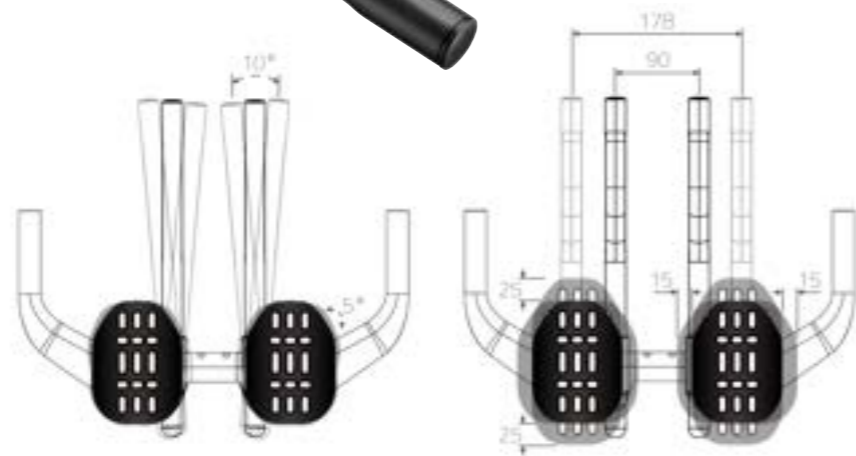

TIME ZONE TT AEROBAR

TTH-17
 MATERIAL: UD CARBON
 WIDTH: 400MM
 EXTENSION BAR RISE: 30MM
 LENGTH: MAX. 300MM(C TO TOP) , MIN. 240MM
 EXTENSION BAR: S BAR, UP / DOWN ANGLE: 20°
 EXTENSION BAR: S BAR, R / L ANGLE: 10°
 ARMRESTS R / L ADJUSTABLE : R/30MM, L/30MM
 ARMRESTS F / B ADJUSTABLE : F/50MM, B/50MM
 ARMREST'S + / - ADJUSTABLE ANGLE: 10°(+/-5°)
 OPTION SPACERS: 20MM OR 40MM OR 60MM(20+40MM)
 COMPATIBLE WITH D12
 WEIGHT: 745G (MIN STACK)

TRIATHLON - ENDURANCE MODE TT - COMBAT MODE
SMART BAR GRIP

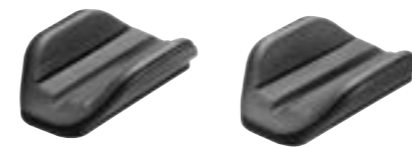

TIME ZONE EVO ARM CUP

TTH-18P
 MATERIAL: EVA
 WEIGHT: 25G / PAIR
 ELBOW PAD OF TIME ZONE AEROBAR



TIME ZONE EVO ARM CUP

TTH-18EP
 MATERIAL: REINFORCED ENGINEERING PLASTIC / EVA
 WEIGHT: 145G / PAIR
 ELBOW PAD OF TIME ZONE AEROBAR



TIME ZONE AEROBAR SPACER KIT

TTH-1761M
 MATERIAL: AL6061
 WEIGHT: 345G / SET
 20MM SPACER/40MM SPACER/BRIDGE AND BOLTS
 FOR 20MM/40MM/60MM SPACERS ARE INCLUDED



FRONT



REVERSE



TIME ZONE TRI AEROBAR

TTH-18
 MATERIAL: UD CARBON
 WIDTH: 400MM
 EXTENSION BAR ANGLE: 34°
 LENGTH: MAX. 300MM(C TO TOP) , MIN. 240MM
 EXTENSION BAR: J BAR, UP / DOWN ANGLE: 20°
 EXTENSION BAR: J BAR, R / L ANGLE: 10°
 ARMRESTS R / L ADJUSTABLE : R/30MM, L/30MM
 ARMRESTS F / B ADJUSTABLE : F/50MM, B/50MM
 ARMREST'S + / - ADJUSTABLE ANGLE: 10°(+/-5°)
 OPTION SPACERS:20MM, 40MM OR 60MM (20+40MM)
 COMPATIBLE WITH D12
 WEIGHT: 755G (MIN STACK)

SIROCCO AERO MINI CLIP-ON

TTH-27
 MATERIAL: REINFORCED ENGINEERING PLASTIC
 LENGTH: 140MM
 EXTENTION BAR ANGLE: 45°
 HANDLEBAR MOUNTED Ø: 31.8MM
 WEIGHT: 336G(TBD)



SIROCCO MINI CLIP-ON

TTH-19
 MATERIAL: UD CARBON
 LENGTH: MAX 213MM
 EXTENTION BAR ANGLE: 45°
 HANDLEBAR MOUNTED Ø: 31.8MM
 ARMRESTS F / B ADJUSTABLE : 46MM
 WEIGHT: 370G(WITH C CLAMP)
 377G(WITH ROUND CLAMP)
 362G(WITH SQUIRE CLAMP)
 STEM MOUNTED FOR ITU COMPLIANCE



SIROCCO PAD

TTH-19P
 MATERIAL: PLUS FOAM
 WEIGHT: 20G



SIROCCO ADAPTOR KIT (HANDLEBAR-MOUNTED)

TTH-1961C
 MATERIAL: AL6061
 CLAMP Ø: 31.8MM
 WEIGHT: 99G / SET



TTH-19-2



Handlebar Mounted



TTH-19-1

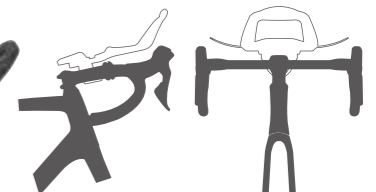

Stem Mounted

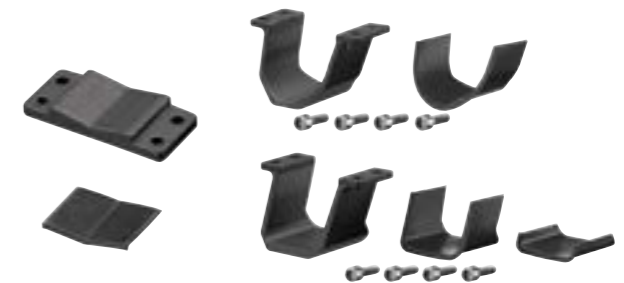

SIROCCO ADAPTOR KIT (STEM-MOUNTED)

TTH-1961S
 MATERIAL: AL6061
 WEIGHT: 91G / SET (ROUND STEM MOUNTED)
 106.5G / SET (ROUND STEM MOUNTED)

IMPEL MINI CLIP-ON

TTH-13
MATERIAL: CARBON
CLAMP Ø: 31.8MM
LENGTH: 168MM
OPTION SPACERS: 30MM
WEIGHT: 225G



IMPEL SPACER

TTH-13M
MATERIAL: AL6061
HEIGHT: 30MM
WEIGHT: 96G / SET



IMPEL PAD

TTH-13P
MATERIAL: LYCRA+EVA
WEIGHT: 96G / PAIR



FALCON TT BAR PAD

TTH-15P
MATERIAL: EVA
WEIGHT: 13G / PAIR

FALCON MINI CLIP-ON (HANDLEBAR MOUNTED)

TTH-14
MATERIAL: AL6061
CLAMP Ø: 31.8MM
LENGTH: MAX 183MM(C TO TOP), MIN 143MM
EXTENSION: U BAR, UP 29MM(C TO C)
ARMREST'S R/L ADJUSTABLE: R/30MM, L/30MM
ARMREST'S +/- ADJUSTABLE ANGLE: 15°(+/-7.5°)
OPTION SPACERS: 20/40/60MM
WEIGHT: 407G (WITH PAD)



FALCON CLIP-ON ADAPTOR KIT (STEM-MOUNTED)

TTH-1461S
MATERIAL: AL6061
WEIGHT: 74.5G / SET



ADAPTOR KIT FOR SQUARE STEM BODY

MATERIAL: AL6061
WEIGHT: 106.5G / SET, 478G(WITH TTH-14)



ADAPTOR KIT FOR ROUND STEM BODY

MATERIAL: AL6061
WEIGHT: 91G / SET, 464G(WITH TTH-14)



TT CARBON EXTENSION S BEND

TTH-25
MATERIAL: CARBON
CLAMP Ø: 31.8MM
EXTENSION BAR RISE: 30MM
LENGTH: MAX. 300MM(C TO TOP) , MIN. 240MM
ARMRESTS R / L ADJUSTABLE : R/30MM, L/30MM
ARMRESTS F / B ADJUSTABLE : F/50MM, B/50MM
ARMREST'S + / - ADJUSTABLE ANGLE: 10°(+/-5°)
OPTION SPACERS: 20/40MM/60MM
WEIGHT: 420G
COLOR: GLOSSY/MATTE



TRI CARBON EXTENSION J BEND

TTH-26
MATERIAL: CARBON
CLAMP Ø: 31.8MM
EXTENSION BAR ANGLE: 34°
LENGTH: MAX. 300MM(C TO TOP) , MIN. 240MM
ARMRESTS R / L ADJUSTABLE : R/30MM, L/30MM
ARMRESTS F / B ADJUSTABLE : F/50MM, B/50MM
ARMREST'S + / - ADJUSTABLE ANGLE: 10°(+/-5°)
OPTION SPACERS: 20/40MM/60MM
WEIGHT: 430G
COLOR: GLOSSY/MATTE



FALCON TT ALLOY EXTENSION S BEND

TTH-15
MATERIAL: AL6061
CLAMP Ø: 31.8MM
EXTENSION BAR RISE: 29MM
LENGTH: MAX 303MM(C TO TOP), MIN 253MM
ARMRESTS R / L ADJUSTABLE : R/30MM, L/30MM
ARMRESTS F / B ADJUSTABLE : F/50MM, B/50MM
ARMREST'S + / - ADJUSTABLE ANGLE: 10°(+/-5°)
OPTION SPACERS: 20/40/60MM
WEIGHT: 450G (WITH PADS)

FALCON TRI ALLOY EXTENSION J BEND

TTH-16
MATERIAL: AL6061
CLAMP Ø: 31.8MM
EXTENSION BAR ANGLE: 40°
LENGTH: MAX 303MM(C TO TOP), MIN 253MM
ARMRESTS R / L ADJUSTABLE : R/30MM, L/30MM
ARMRESTS F / B ADJUSTABLE : F/50MM, B/50MM
ARMREST'S + / - ADJUSTABLE ANGLE: 10°(+/-5°)
OPTION SPACERS: 20/40/60MM
WEIGHT: 462G (WITH PADS)



**TIME ZONE
AEROBAR PAD**

TTH-17P
MATERIAL: LYCRA+EVA
WEIGHT: 12G / PAIR



**ARMREST STACK
SPACER KIT 20MM**

TTH-15M
MATERIAL: AL6061
HEIGHT: 20MM
WEIGHT: 90G / SET



**ARMREST STACK
SPACER KIT 40MM**

TTH-15M
MATERIAL: AL6061
HEIGHT: 40MM
WEIGHT: 158G / SET



**ARMREST STACK
SPACER KIT 60MM**

TTH-15M
MATERIAL: AL6061
HEIGHT: 60MM
WEIGHT: 226G / SET

TT ALLOY LEVER

TTL-O2
MATERIAL: AL6061
SIZE: L126 X W18.7 X H70.8MM
INNER Ø: 20MM
WEIGHT: 188G / PAIR



TIME ZONE HYDRATION SYSTEM

THS-01
MATERIAL: HDPE+REINGORCED ENGINEERING PLASTIC
CAPACITY: 800ML
SIZE: L262 X W71 X H191MM
WIDTH: 90MM TO 120MM (CENTER TO CENTER)
WEIGH: 396G
COMPATIBLE WITH GARMIN AND GO PRO



**FALCON REAR
HYDRATION SYSTEMS**

BC-31
MATERIAL: AL6061+PLASTIC
CAPACITY: 2 OR 1 BOTTLES / 1 CO2 CANISTER
ADJUSTMENT: ANGLE UP TO 45°, UP TO 30MM
WEIGHT: 220G



SIROCCO REAR HYDRATION SYSTEM

BC-40B/BC-40(With bottle cages)
 MATERIAL: AL6061+PLASTIC
 CAPACITY: 2 OR 1 BOTTLES / 2 CO2 CANISTER
 ADJUSTMENT: ANGLE UP TO 90 DEGREE
 WEIGHT: BC-40B 180G/BC-40 263G



TRI-POWER UNIT

BAG-01
 MATERIAL: TPV+ABS
 SIZE: L220 X W42 X H66MM
 CAPACITY: 260CM³
 WEIGHT: 130G



LIMITED EDITION-GUEE

LIMITED EDITION-JE22

CARBON TRACK HANDLEBAR

RA-548
 MATERIAL: CARBON FIBER
 WIDTH: 340/350/360/380/400MM
 REACH: 110MM
 DROP: 149MM
 BARBORE Ø: 31.8MM
 GRIP DIAMETER Ø: 26MM
 WEIGHT: 345G (360MM)



BULL HORN ALLOY BASEBAR

RA-499DB7-8
 MATERIAL: AL7075
 BARBORE Ø: 31.8MM
 WIDTH: 400M
 WEIGHT: 260G



COUGAR AERO BASEBAR

RA-547
 MATERIAL: AL6061
 WIDTH: 400/420/440MM
 BARBORE Ø: 31.8MM
 WEIGHT: 319G (420MM)
 UCI COMPLIANT 3:1
 AERODYNAMIC



TRI COLLECTION SPEC

TT BAR

	TTH-17	TTH-18	TTH-27	TTH-19	TTH-13	TTH-14	TTH-25	TTH-26	TTH-15	TTH-16
CLAMP Ø	31.8	31.8	31.8	31.8 / STEM	31.8	31.8	31.8	31.8	31.8	31.8
HANDLE ADJUSTMENT(MM)	-	-	-	-	-	-	-	-	-	-
PAD HOLDER ADJUSTMENT(MM)	L 30 F 50 R 30 B 50	L 30 F 50 R 30 B 50	-	F 46 B 46	-	L 30 R 30	L 30 R 30	L 30 R 30	L 30 R 30	L 30 R 30
PAD HOLDER ANGLE	L/R 10°(+/- 5°)	L/R 10°(+/- 5°)	-	-	-	L/R 15°(+/- 7.5°)	L/R 15°(+/- 7.5°)	L/R 15°(+/- 7.5°)	L/R 15°(+/- 7.5°)	L/R 15°(+/- 7.5°)
CLAMP ADJUSTMENT(MM)	-	-	-	-	-	-	-	-	-	-
WING WIDTH(MM)	400	400	-	-	-	-	-	-	-	-
EXTENSION LENGHT(MM)	MAX 300 MIN 240	MAX 300 MIN 240	213	213	168	-	MAX 300 MIN 240	MAX 300 MIN 240	MAX 303 MIN 253	MAX 303 MIN 253
EXTENSION BAR ANGLE	-	34°	45°	45°	-	-	-	34°	-	40°
EXTENSION ADJUSTMENT ANGLE	+/- 20° L/R 10°	+/- 20° L/R 10°	-	-	-	-	-	-	-	-
EXTENSION BAR RISE(C TO C)	30	-	-	-	-	29	20	-	28	-
OPTION SPACERS(MM)	20/40/60	20/40/60	-	-	30	20/40/60	20/40/60	20/40/60	20/40/60	20/40/60
LOGO APPLICATION	COLOR DECAL	COLOR DECAL	COLOR DECAL	COLOR DECAL	COLOR DECAL	COLOR DECAL	COLOR DECAL	COLOR DECAL	COLOR DECAL	COLOR DECAL
FINISH	MATT BLACK SHINY BLACK	MATT BLACK SHINY BLACK	MATT BLACK	MATT BLACK	MATT BLACK SHINY BLACK	SB BLACK	MATT BLACK SHINY BLACK	MATT BLACK SHINY BLACK	SB BLACK	SB BLACK
MATERIAL	UD CARBON	UD CARBON	PLASTIC	UD CARBON	UD CARBON	AL6061	UD CARBON	UD CARBON	AL6061	AL6061
BOLTS	STAINLESS STEEL	STAINLESS STEEL	STAINLESS STEEL	STAINLESS STEEL	SCM-435	SCM-435	STAINLESS STEEL	STAINLESS STEEL	SCM-435	SCM-435
WEIGHT	745G	755G	336G	370G(C clamp) 377G(Round clamp) 362G(Square clamp)	225G	407G	420G	430G	450G	462G

BASEBAR

	BULL HORN ALLOY	AERO ALLOY BASEBAR
BARBORE	31.8	31.8
WIDTH(MM)	400	400/420/440
CABLE ROUTING	GROOVES	GROOVES
FINISH	SB BLACK	SB BLACK
MATERIAL	AL7075	AL6061
WEIGHT	260G	319G(420mm)

TT LEVER

	LEVER
BODY MATERIAL	AL6061
SIZE(MM)	L 126 X W 18.7 X H 70.8
INNER Ø(MM)	20
WEIGHT	170G / PAIR



EI



CONTROL
E-SET

EI SERIES



LYNX 31.8 EI BAR

ATB-310DB68
 MATERIAL: AL6061
 BARBORE Ø: 31.8MM
 WIDTH: 750/800MM
 BACK SWEEP: 6°
 WEIGHT: 305G (800MM)



LYNX 31.8 CARBON EI BAR

ATB-312
 MATERIAL: CARBON
 BARBORE Ø: 31.8MM
 WIDTH: 720/740/750/800MM
 RISE: 8MM
 BACK SWEEP: 6°
 WEIGHT: 185G (800MM)

ZEDLER PASS



Internal cable tunnel system
 With ATB-958 Stem



E-I ±5° STEM

ST-EB-01
 MATERIAL: AL6061
 HANDLEBAR Ø: 31.8
 STEERER Ø: 1-1/8"
 LENGTH: 80/90/100/110MM
 ANGLE: +/- 5°
 WEIGHT: 238G (100MM)
 COMPATIBLE WITH BOSCH KIOX CRADLE



E-I ADJUSTABLE STEM

ST-EB-02
 MATERIAL: AL6061
 HANDLEBAR Ø: 31.8
 STEERER Ø: 1-1/8"
 LENGTH: 90/100/110/120MM
 ANGLE: +25° ~ -30°
 WEIGHT: 356G (100MM)
 INTEGRATED WITH BOSCH KIOX DISPLAY



LYNX FULL INTERNAL -10° DROP STEM

ATB-958
 MATERIAL: AL6061
 HANDLEBAR Ø: 31.8MM
 STEERER Ø: 1-1/8"
 LENGTH: 60/70/80/90MM
 ANGLE: -10°
 WEIGHT: 207G (60MM)



| EI BARS

	ATB-310	ATB-312
BARBORE	31.8	31.8
600		
620		
640		
650		
660		
680		
690		
700		
710		
720		V
740		V
750	V	V
760		
780		
800	V	V
BACK SWEEP	6°	6°
UP SWEEP	0°	0°
RISE(MM)	0	8
MATERIAL	AL6061	CARBON
LOGO APPLICATION	COLOR DECAL	COLOR DECAL
FINISH	SB BLACK	CARBON
WEIGHT	305G (800MM)	185G (800MM)

| EI STEM

	ST-EB-01	ST-EB-02	ATB-958
ANGLE	±5°	+25° ~ -30°	-10°
40			
45			
50			
60			V
70			V
80	V		V
90	V	V	V
100	V	V	
110	V	V	
120		V	
130			
STACK HEIGHT	41	-	39
STEERER Ø	1-1/8"	1-1/8"	1-1/8"
BARBORE Ø	31.8	31.8	31.8
BODY	AL6061	AL6061	AL6061
FACEPLATE	AL6061	AL6061	AL6061
BOLT	STAINLESS STEEL	SCM-435	SCM-435
FINISH	SB BLACK	SB BLACK	SB BLACK
WEIGHT	238G (100MM)	356G (100MM)	207G (60MM)



I NON SERIES

SIROCCO INTEGRATED CARBON HANDLEBAR

RA-550
 MATERIAL: UD CARBON
 BARBORE Ø: 31.8MM
 WIDTH: 400/420/440MM
 REACH: 75MM
 DROP: 125MM
 FLARE: 0°
 WEIGHT: 275G(420MM)TBD
 COMPATIBLE WITH EW-RS910



SIROCCO INTEGRATED -8° CARBON DROP STEM

RAS-108
 MATERIAL: UD CARBON
 HANDLEBAR Ø: 31.8MM
 STEERER Ø: 28.6MM
 LENGTH: 90/100/110/120MM
 ANGLE: -8°
 WEIGHT: 186G (100MM)TBD



SM-07
 MATERIAL: ALLOY
 WEIGHT: 32G



STOKER +35° STEM

ATB-922
 MATERIAL: AL6061
 HANDLEBAR Ø: 25.4/31.8MM
 STEERER Ø: 29.8/31.6MM
 ANGLE: +35°
 LENGTH: 190-230MM/215-255MM
 WEIGHT: 352G (190-230MM, Ø29.8/Ø25.4)



±40° DROP STEM

RAS-104
 MATERIAL: AL6061
 HANDLEBAR Ø: 31.8MM
 STEERER Ø: 28.6MM
 ANGLE: ±40°
 LENGTH: 60/70/80/90/100/110/120/130MM
 WEIGHT: 146G (60MM)



TIMANIA FLO ROAD HANDLEBAR

RA509-8
 MATERIAL: TI + UD CARBON
 BARBORE Ø: 31.8MM
 WIDTH: 400/420/440MM
 REACH: 75MM
 DROP: 130MM
 WEIGHT: 235G (W420MM)



MONOCOQUE FORMING PROCESS
 INSIDE TITANIUM TUBE

-17° DROP STEM

ATB-960
 MATERIAL: AL6061
 HANDLEBAR Ø: 31.8MM
 STEERER Ø: 28.6MM
 LENGTH: 60/70/80/90/100/110MM
 ANGLE: -17°
 WEIGHT: 163G (60MM)



IATB-960CH



Optional Plastic cover for internal cable routing



ECCENTRIC RING

CR-48/SRAM
 CR-49/SHIMANO
 MATERIAL: AL7075
 TYPE: 53/41, 51/36
 BCD: 130(53/41) (SRAM)
 110(53/41, 51/36) (SRAM, SHIMANO)
 WEIGHT: 211G (51/36, 5 hole), 221G (53/41, 4 hole)

FTP up 6%
Lower input 6%

- 6% Power ⚡
- 6% Cadence ⚡
- Pedaling Naturally Round
- Easier Transition From Bike To Running

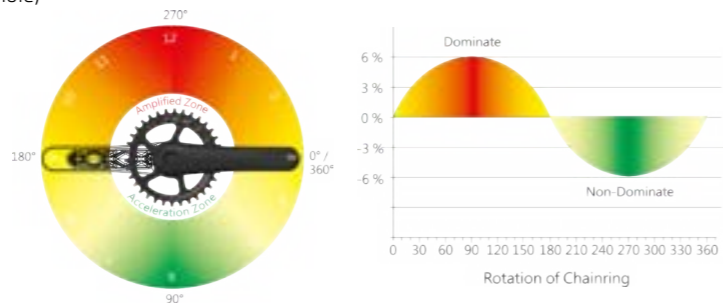

SIROCCO 3545 CL

RIM-79 / RIM-89-DB
 MATERIAL: CARBON FIBER
 RIM TYPE: 700C CLINCHER, ENDURO BEARINGS
 RIM WIDTH(OUTSIDE): 23.8MM
 RIM WIDTH(INSIDE): 16.8MM
 RIM DEPTH: 35~45MM
 TIRE WIDTH: 20~35C
 AXLE WIDTH (O.L.D.) F: 100MM / R: 130MM(RIM-79)
 AXLE WIDTH (O.L.D.) F: 100MM / R: 142MM(RIM-89)
 SPOKE: F 20H / R 24H 1:1(RIM-79)
 SPOKE: F 24H / R 24H 1:1(RIM-89)
 WEIGHT: 1550G / PAIR(RIM-79), 1730G / PAIR(RIM-89)
 SHIMANO 11S COMPATIBLE
 UCI IMPACT TEST PASSED
 TUBELESS READY

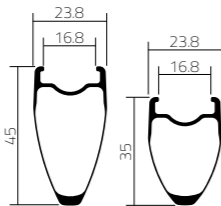

CONTROLTECH 700C ALLOY WHEELS

RIM-80
 MATERIAL: AL6061
 RIM TYPE: 700C CLINCHER
 RIM WIDTH(OUTSIDE): 23MM
 RIM WIDTH(INSIDE): 17MM
 RIM DEPTH: 30MM
 AXLE WIDTH (O.L.D.): F 100MM/ R 130MM
 SPOKES: F 20H / R 24H
 WEIGHT: 2,082G / PAIR
 SHIMANO 11S OR CAMPY COMPATIBLE
 TUBELESS READY

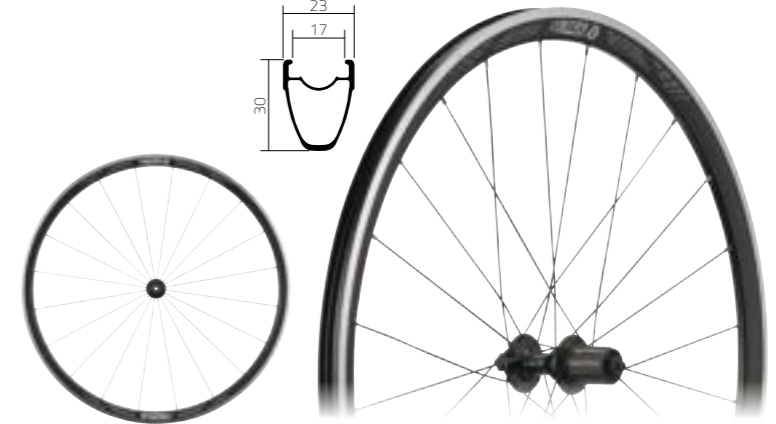
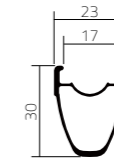

CONTROLTECH 700C DISC

RIM-90
 MATERIAL: AL6061
 RIM TYPE: 700C CLINCHER
 RIM WIDTH(OUTSIDE): 25MM
 RIM WIDTH(INSIDE): 18MM
 RIM DEPTH: 28MM
 AXLE WIDTH (O.L.D.): F 100MM/ R 142MM
 SPOKES: F 20H / R 24H
 WEIGHT: 1,900G / PAIR
 SHIMANO 11S OR CAMPY COMPATIBLE
 TUBELESS READY

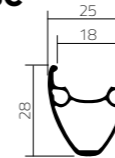

CONTROLTECH 700C CARBON WHEELS

RIM-91-2
 MATERIAL: CARBON FIBER
 RIM TYPE: 700C CLINCHER
 RIM WIDTH(OUTSIDE): 26MM
 RIM WIDTH(INSIDE): 19MM
 RIM DEPTH: 40MM
 AXLE WIDTH (O.L.D.): F 100MM/ R 130MM
 SPOKES: F 20H / R 24H
 WEIGHT: 1,870G / PAIR
 SHIMANO 11S TUBELESS READY

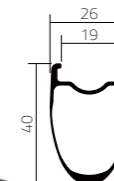

CONTROLTECH 650B ALLOY WHEELS

RIM-94
MATERIAL: AL6061
RIM TYPE: 650B CLINCHER
RIM WIDTH(OUTSIDE): 29.2MM
RIM WIDTH(INSIDE): 25MM
RIM DEPTH: 21MM
AXLE: (O.L.D): F 100MM, TA-12 / R 142MM, TA-12
SPOKES: F 28H / R 28H
WEIGHT: 1,980G / PAIR
MAX TIRE SIZE: 48C
FREEHUB: STEEL, SHIMANO 11S HG OR SRAM XD DRIVE
TUBELESS READY

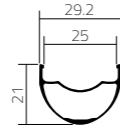

CONTROLTECH 700C ALLOY WHEELS

RIM-96
MATERIAL: AL6061
RIM TYPE: 700C CLINCHER
RIM WIDTH(OUTSIDE): 24MM
RIM WIDTH(INSIDE): 19MM
RIM DEPTH: 28MM
AXLE: (O.L.D): F 100MM, TA-12 / R 142MM, TA-12
SPOKES: F 28H / R 28H
WEIGHT: 2,100G / PAIR
MAX TIRE SIZE: 38C
FREEHUB: STEEL, SHIMANO 11S HG OR SRAM XDR
TUBELESS READY

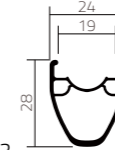

CONTROLTECH 650B PLUS ALLOY WHEELS

RIM-95
MATERIAL: AL6061
RIM TYPE: 650B PLUS CLINCHER
RIM WIDTH(OUTSIDE): 40MM
RIM WIDTH(INSIDE): 35MM
RIM DEPTH: 18MM
AXLE WIDTH (O.L.D): F 110MM, TA-15 / R 148MM, TA-12
SPOKES: F 32H / R 32H
WEIGHT: 2,200G / PAIR
MAX TIRE SIZE: 2.8"
FREEHUB: STEEL SHIMANO 11S OR SRAM XD DRIVE
TUBELESS READY

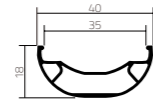

CONTROLTECH 700C ALLOY WHEELS

RIM-97
MATERIAL: AL6061
RIM TYPE: 700C CLINCHER
RIM WIDTH(OUTSIDE): 24MM
RIM WIDTH(INSIDE): 19MM
RIM DEPTH: 28MM
AXLE: (O.L.D): F 100MM, QR-9 / R 142MM, QR-9
SPOKES: F 28H / R 28H
WEIGHT: 2,100G / PAIR
MAX TIRE SIZE: 38C
FREEHUB: STEEL SHIMANO 11S HG OR SRAM XD DRIVE
TUBELESS READY

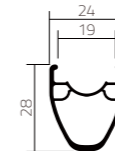

| ACCESSORIES

ADAPT

SC-91
MATERIAL: AL6061
INNER Ø: 31.8/34.9MM
WEIGHT: 26G
HOLLOW DESIGN



CONTROL SEAT CLAMP

SC-74QR
MATERIAL: AL2014
INNER Ø: 31.8/34.9MM
WEIGHT: 52G
STAINLESS STEEL AXLE
ALUMINUM CLAMP LEVER



SETTLE

SC-93
MATERIAL: AL7075
INNER Ø: 31.8/34.9MM
WEIGHT: 14G(34.9MM)
HOLLOW DESIGN



SETTLE II SET CLAMP

SC-112
MATERIAL: AL6061
INNER Ø: 36.4MM
WEIGHT: 25G



CHAIN CATCHER

AC-78
MATERIAL:AL6061
LENGTH :100MM WITH 2 BOLT M5
WEIGHT:20G

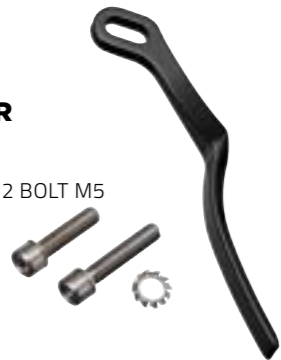

ISCG-05 CHAIN GUIDE

AC-83
MATERIAL: AL7075
SUITABLE FOR NARROW-WIDE
30-40T CHAINRING(ROUND
CHAINRING),
30-38T CHAINRING(OVAL
CHAINRING), ADJUSTABLE DESIGN
WEIGHT:40G



SIDE-OPEN BOTTLE CAGE

BC-34
MATERIAL: PLASTIC
WEIGHT: 55G
COLOR: RED/BLUE/GRAY



RIB BOTTLE CAGE

BC-38
MATERIAL: PA66+11%GF
WEIGHT: 35G



SIDE-OPEN BOTTLE CAGE II

BC-39
MATERIAL: PA66+30%GF
WEIGHT: 43G



CONVERSION ADAPTER FROM CENTER LOCK TO SIX-BOLT ROTOR

AC-79
MATERIAL:AL6061
WEIGHT:34G



RHS HEADSET

HS-958
TOP COVER MATERIAL: REINGORCED ENGINEERING PLASTIC
SIZE: UPPER IS52/28.6, LOWER IS52/40
WEIGHT: 76.5G
COMPATIBLE TO TOKEN CABLE BOX SYSTEM AUTHORIZED BY TOKEN





INTEGRATED SPLIT SPACER

HSS-11
MATERIAL: NYLON+GLASS FIBER
HEIGHT: 5/10MM
WEIGHT: 2.5G(5MM), 5G(10MM), 5G(TOP SPACER)
FOR RAS-88/RAS-101/ATB-960



CARBON SPACERS

HSS-13
MATERIAL: CARBON
STEERER Ø: 28.6MM
HEIGHT 5/10/15/20/25MM
WEIGHT: 1.4G(5MM)/2.8G(10MM)



TERMINATOR MTB HANDLEBAR EXTENSION PLUG

AC-63
MATERIAL: AL6061
EXTERNAL: 22.2MM
INNER: 17.6-20.2MM
FINISH: BLACK
WEIGHT: 37G / PAIR



TERMINATOR ROAD HANDLEBAR EXTENSION PLUG

AC-62
MATERIAL: AL6061
EXTERNAL: 23.8MM
INNER Ø: 17.6-20.2MM
FINISH: BLACK
WEIGHT: 45G / PAIR



COMP ALLOY

CAP-29
MATERIAL: AL6061
STEERERS Ø: 23.3MM ~ 25.4MM
WEIGHT: 30G
CARBON STEERER FORK FRIENDLY,
INTERNAL EXPANDING SYSTEM



DBH(DI2 BATTERY HOLDER)

AC-69
MATERIAL: RUBBER
SEATPOST Ø: 27.2/30.9/31.6MM
WEIGHT: 6G(Ø27.2MM)
HOLLOW DESIGN
USE FOR SHIMANO INTERNAL BATTERY(SM-BTR2) SECURELY HIDE YOUR DI2 BATTERY WITHIN YOUR SEATPOST

FALCON WATER BOTTLE

WBT-05
MATERIAL: PLASTIC
VOLUME: 600ML
WEIGHT: 70G



6 IN 1 BIKE TOOL

TL22
MATERIAL AL6061+CR-V
SPEC: HEX 3MM/HEX 4MM/HEX 5MM/HEX 6MM/TORX T25/FLAT 5



10 IN 1 BIKE TOOL

TL23
MATERIAL AL6061+CR-V
SPEC: HEX 2MM/HEX 2.5MM/HEX 3MM/HEX 4MM/HEX 5MM/HEX 6MM/HEX 8MM/TORX T25/FLAT 5/PH2



16 IN 1 BIKE TOOL

TL24
MATERIAL AL6061+CR-V
SPEC: HEX 2MM/HEX 2.5MM/HEX 3MM/HEX 4MM/HEX 5MM/HEX 6MM/HEX 8MM/TORX T25/FLAT 5/PH2

Controltech Worldwid Distributors

Country	Distributor Company Name	Address	Tel. No.	Web
China	KINGFORCE	No. 155 Baiyundu Rd., Ludu Town, Taicang City, Jiangsu, China	+86-512-5328-9080	www.bhbikeschina.com
Taiwan	Dalux Int. Co. Ltd	No. 12, Ln. 538, Sec. 1 Yuandong Road, Yuanlin City, Changhua, Taiwan	+886-4-8353575	www.krex.com.tw
Taiwan	Dacaltech Co. Ltd.	12F., No. 325, Renyi St., Sanchong Dist., New Taipei City 241, Taiwan (R.O.C.)	+886-2-28572687	www.dacal.bike
Singapore	New Era Cycle	#01-04, 14 Arumugam Road, LTC Building C, 新加坡 409959	+65 6100 8645	neweracycle.com
Indonesia	Bagus bike	Komp. Ruko sektor 7 blok rrn 61 tangerang 15310, Indonesia	+62-21-5371115	www.bagusbike.com
Philippines	Bike One Cycle Mart	Unit 9 Pasda Bldg, Araneta Ave. Cor P. Florentino st Brgy. Sto Domingo Quezon City, Philippines	+63-2516-3553	www.bikeonecycle.com
Japan	Magic One CO. LTD.	〒593-8322 大阪府堺市西区津久野町3丁2-4	+81 72-263-5135	mgc01.com
Korea	BIKEEMCS	Yeongil Building Level 1, Heungseon-ro 102, Uijeongbu-si, Gyeonggi-do, 11672	031-875-6242	http://bikemcs.co.kr/
India	Bicycle Paradise (B. S. Enterprises)	SR-8, Nursery Circle, Vaishali Nagar, Jaipur-302021	+91-9649977772	bicycleparadise.jaipur@gmail.com
Vietnam	Bike Life	83 Phạm Thái Bường, Tân Phong, Quận 7, Hồ Chí Minh	+84 28 5412 4217	www.facebook.com/bikelife.com.vn
Qatar	Carbon Wheels Qatar	Shop 141 Qanat Quartier, The Pearl (Opposite the Kempinski Roundabout)	+974 4441 9048	carbonwheels.qa
Cambodia	Flying Bikes 2	No. 131 BEO, Pasteur (St51), 12210 Phnom Penh, Cambodia	+855 012727717	flyingbikes2.com
COSTA RICA, NICARAGUA, PANAMA	DECAVISA DE ALAJUELA SA	Calle Lotes Solis, Alajuela, Alajuela. Costa Rica .20102	+506 50624377800	www.decavisa.com
Mexico	BIKE STOP S.A. DE C.V.	Calle Isidro Félix de Espinosa #8, Cimatario, 76030 Santiago de Querétaro, Qro.	+52 442 224 1089	bikestop.com.mx
Puerto Rico And Caribbean Area	Pro Cycling Center	St. #2, KM 123; Caimital Alto, Aguadilla PR 00603	+1 787-705-7242	www.sperosportswear.com
Colombia	BIKE SUPPLY S.A.S.	Calle 23 # 68b-32 Bogota, Colombia	+57 3007319582	
GREAT BRITAIN (UNITED KINGDOM)	BOB ELLIOT & CO LTD	Unit C4 Binary Court Matrix Park Western Avenue Buckshaw Village Chorley PR7 7NB	+44 1257 248480	www.bob-elliott.co.uk
CZECH REPUBLIC & SLOVAKIA	KCK Cyklosport	Bartošova 348 765 02 Otrokovice - Kvitkovice	+420 577 217 520	www.kckcyklosport.cz
UKRAINE	Leader Bike	03037 ,Kyiv, Ukraine avn.Lobanovskogo 12	+380442498350	leaderonline.com.ua
FRANCE	SEMC Distribution	7 Rue des Verriers, 68200 Mulhouse	+33 (0)3 89 42 77 45	www.semc.pro/bike/
GERMANY & THE BENELUX AREA	Tehava	Tomeikerweg 31 6161RB Geleen NLD	+31-0-46-4752100	www.tehava.com/en-us
Poland	Merida Polska SP. Z O.O.	UL.M.C. Skłodowskiej 35. 41-800 Zabrze, Poland	+48-32-273-3232	www.rowerymerida.pl
SPAIN & ANDORRA	Bike Difusion	Arkatxa Kalea, 1, 01006 Vitoria-Gasteiz, Araba, Spain	+34 945 15 82 88	www.bikedifusion.com
SOUTH AFRICA	Positive Sports Solutions (Pty) Ltd	2 Regency Drive, Route 21 Office Park, Irene, Centurion 0157, Republic of South Africa	+27 076 423 3416	positivesportssolutions.co.za
AUSTRALIA	LINKSPORTS	21 North Street Leichhardt NSW 2040 Australia	+61 02 9560 7841	www.linksports.com.au
NEW ZEALAND	Don't Stop Pedalling	240Queen Street Richmond, Nelson	+64 210625417	dontstoppedalling.com
ARGENTINA	PEREYRA MAYORISTA DE BICICPARTES	ALEM 660 - LA BANDA 4300 - SANTIAGO DEL ESTE-RO ARGENTINA	+54 385 4272400	pereyramayorista.com.ar

DISTRIBUTORS



DISCONTINUED PRODUCT

MODEL NAME	ITEM NUMBER	SPECIFICATIONS	NOTES
CARBON BOTTLE CAGE	BC-37	ALL SIZE	DISCONTINUED
CORK BAR TAPE	HT-07	ALL SIZE	DISCONTINUED
NAPLAM DUO BAR TAPE	HT-11	ALL SIZE	DISCONTINUED
NAPALM BAR TAPE	HT-12	ALL SIZE	DISCONTINUED
ATOM DUO BAR TAPE	HT-13	ALL SIZE	DISCONTINUED
ATOM BAR TAPE	HT-14	ALL SIZE	DISCONTINUED
VULCANO BAR TAPE	HT-15	ALL SIZE	DISCONTINUED
RACE LIGHT SKEWERS	BT-06	ALL SIZE	DISCONTINUED
TESTY DOUBLE LOCK-ON	GP-12	ALL SIZE	DISCONTINUED
TESTY SINGLE LOCK-ON	GP-13	ALL SIZE	DISCONTINUED
SILICONE MTB GRIPS	GP-16	ALL SIZE	DISCONTINUED
MTB GRIP COLOR WITH HALLOW DESIGN	GP-17	ALL SIZE	DISCONTINUED
MTB GRIP COLOR	GP-18	ALL SIZE	DISCONTINUED
FALCON STEM INTEGRATED SPACER	HSS-14	ALL SIZE	DISCONTINUED
COUGAR HEADSET	HS-957	ALL SIZE	DISCONTINUED
PCS THRU AXLE	QR-41	ALL SIZE	DISCONTINUED
COUGAR FORK	F175I / F176I	ALL SIZE	DISCONTINUED
TIMANIA BOTTLE CAGE	BC-30	ALL SIZE	DISCONTINUED
TUX ROAD FORK	F149I	ALL SIZE	DISCONTINUED
CLS FL4 ROUND ROAD RISE	RA-537	ALL SIZE	DISCONTINUED
LYNX SADDLE I	SD-21	ALL SIZE	DISCONTINUED
LYNX HUB	HUB-41	ALL SIZE	DISCONTINUED
LYNX HUB	HUB-47	ALL SIZE	DISCONTINUED
LYNX PEDAL	PD-04	ALL SIZE	DISCONTINUED
SLA LIGHT SB12 SEATPOST	SP-1560	ALL SIZE	DISCONTINUED
TT CARBON LEVER	TTL-01	ALL SIZE	DISCONTINUED
BULL HORN CARBON BASEBAR	RA-508	ALL SIZE	DISCONTINUED
CLS FL4 ROAD RISER	RA-532	ALL SIZE	DISCONTINUED
MHS HEADSET	HS-952	ALL SIZE	DISCONTINUED
RHS HEADSET	HS-951	ALL SIZE	DISCONTINUED
CONTROL QR	QR-25	ALL SIZE	DISCONTINUED
COMP CAP	CAP-28	ALL SIZE	DISCONTINUED
MST 35 ALLOY FLAT TOP BAR	ATB-282DB6-5 / 7-5	ALL SIZE	DISCONTINUED
MST 35 RISER HANDLEBAR	ATB-283DB6-5 / 7-5	ALL SIZE	DISCONTINUED
FALCON SPEED SADDLE	SD-20	ALL SIZE	DISCONTINUED
HEADSET	HS-955	ALL SIZE	DISCONTINUED



We Are In Better Control



controltechbikes.com

Ride With Better Control



controltechbikes.com

